

# Operation Manual

## Venus 217

Single Tag Printer

575 Prospect St., #211  
Lakewood, New Jersey 08701-5073  
Tel: 732.367.3100



fax: 732.367.7031  
e-mail: [sales@dalemark.com](mailto:sales@dalemark.com)  
website: [www.dalemark.com](http://www.dalemark.com)



## Contents

### Introduction

1. Unpacking .....	2
2. Instructions For Use and Installation Precautions .....	5
3. Safety Precautions .....	7
4. Specification .....	10
5. Parts Name .....	12
(5-1) Front side (5-2) Left side (5-3) Right side (5-4) Operation Panel	
6. Ink Ribbon Setting .....	16
7. Tag Setting .....	19
8. Stacker Setting .....	21
9. Cleaning Machine Parts .....	22
10. Error List .....	24
11. Trouble Shooting .....	25
12. Panel Setting .....	27
13. Internal Setting Instruction .....	31
14. How to Clear Print Data Without Turning off the Power .....	37
15. How to Update Printer Firmware .....	37

## Introduction

Thank you for purchasing our care label printer "Venus211"

Please read this user manual beforehand for the proper use of the printer, and remember to keep this manual safely after reading.

### 1. Unpacking

Please check the carton case carefully and make sure that there are no serious damages or dents on the box.

If you find any damages on the device when unpacking, please contact your vendor immediately.

 <b>ATTENTION</b>	<b>Printer is too heavy. Do not remove it alone. Please unpack with other people, and be careful not to injure your fingers with the carton case.</b>
--	---

When lifting the printer's main body from the carton case, please make sure there is enough and clear space.

Remove it slowly while holding it from the bottom, but be careful not to injure yourself. Please handle it with maximum care because failure to do so may lead to an accident.

Below are the items included.



Operation Manual (this book)



Tag Guide (with magnet) / 2pcs



One-touch-guide / 2pcs



Carton core / 1pc



Weight / 1pc

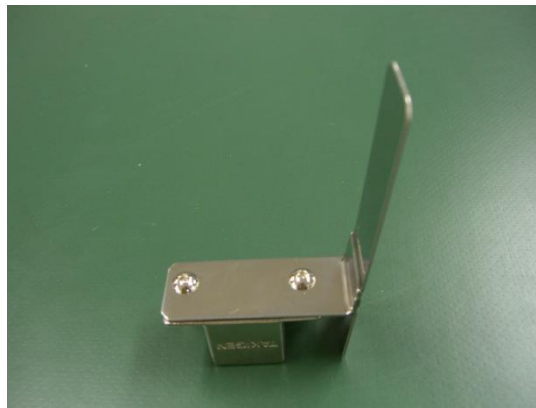

Tag Guide (with magnet) for  
Manual Stacker / 1pc



Power Code / 1pc



USB Cable / 1pc



Flathead screw driver / 1pc



Ball-point hexagon driver (M3) / 1pc



Manual Stacker Plate/ 1pc

- ※ Please note that in case of purchase of an "Auto-Stacker", the Manual Stacker Plate will not be included in this list.
- ※ The power cable included is only made for the purpose of this printer. Please do not use the power cable with other machines. Doing so, may cause fire or electric shock.

## **2. Instructions For Use and Installation Precautions**

For your safe use:

This printer is designed and manufactured with high precision for your safety, however, it is very important that the following safety instructions are fully understood and put into practice. Please read the following instructions carefully for the proper use of the device.

 <b>Warning</b>	Indicates that failure to follow directions or warning may cause serious injuries.
--	--

### ***Unpacking, Installation, and Transportation***

- ⊙ The printer is heavy. Hold the device from the bottom and lift it out of the box carefully.
- ⊙ Put the printer on a strong and stable table.
- ⊙ Place the printer on the table, but be cautious because if not properly positioned there is a possibility of dropping it from the table.
- ⊙ During operation, pay maximum attention to your hands not to get caught in between the device. Please be careful when dealing with the device.

### ***Maintenance, Inspection, and Adjustment***

- ⊙ Please make sure that the printer and the computer are switched off, the power cord is unplugged when conducting maintenance, inspection, and adjustment.
- ⊙ Do not plug in the electric cord with wet hands. Failure to follow these instructions may lead to an electric shock or injuries.
- ⊙ Do not make any alterations or dis-assemble the parts of the devices unless directed. Failure to follow these instructions may ignite fire or malfunction of the equipment and may cause injuries.
- ⊙ If you find dust or dirt on the edge of the power connector or its interface, please wipe it with a dry cloth. Failure to do so may ignite fire.

 <b>Caution</b>	Indicates that failure to follow directions may cause minor injuries to you or damage the equipment.
--	--

### ***During Operation***

- ⊙ Do not touch the rollers during operation.  
Do not touch the pulse motor in the printer during operation. Failure to follow these directions may lead to injuries.

### ***Changing Ink Ribbons and Tapes***

- ⊙ Be careful when handling the thermal head since it becomes very hot after use. It may cause injuries and you may be scalded.

### ***Cleaning and changing the thermal head***

- ⊙ Make sure that the power supply is switched off.
- ⊙ Please be careful when handling the thermal head after switching off the device because it stays very hot for a while.

Failure to follow these instructions may lead to an electric shock or injuries.

### ***Cleaning the thermal head, platen roller, and sensor device***

- ⊙ When cleaning the thermal head, the platen roller, and the sensor, you are required to use isopropyl alcohol, methanol or ethanol. Do not use any other agent for cleaning.

Failure to do so may lead to damages to the equipment.

- ⊙ Be careful when handling isopropyl alcohol and methanol since they are highly flammable.
- ⊙ Avoid cleaning the thermal head when it is hot.

This may ignite fire on the equipment.

## **Installation location**

Place the printer on a strong and vibration-free table and keep it well-ventilated with enough distance from the wall or other equipment since it generates heat.

- (1) Make sure that power supply is installed in a vibration-free area without noise and static electricity.
- (2) Do not expose the printer to direct sunlight.  
Do not install the printer where temperatures and humidity changes rapidly.
- (3) Do not place the printer in a dusty area.
- (4) Do not use long cables when connecting the devices.

### **3. Safety Precautions**

#### **■ Foreword**

Before using this product, make sure to read and understand these SAFETY PRECAUTIONS & the OPERATION MANUAL carefully.

Please keep the Operation Manual carefully near the device so as to be able to refer to it when operating this product.

#### **About the power source**

- Do not handle the electric cord with wet hands.  
Doing so may cause an electrical shock.
  
- Please make sure the electric cord is properly plugged in.  
Failure to do so may cause fire or electrical shock.
  
- Do not use a cable with broken insulation.  
Failure to do so may cause fire or electrical shock.
  
- Please make sure to use earth.  
If the cable used does not have an earth connection, it may cause an electrical shock.

#### **If abnormality occurs**

- In case of any abnormalities, e.g. Smoke or smell coming out from the printer, please switch off the device, remove the power cord and contact us or your vendor immediately. Failure to do so may cause fire or electric shock to the person handling the device.

#### **Others**

- Do not dismantle or tamper with the machine.  
Inside the machine there are high voltage electrical parts which may cause fire and electrical shock.  
If the device needs maintenance or repair, please contact the dealer you purchased the device from or our service counter.



### **About cleaning liquid**

- The cleaning liquid is a highly inflammable solvent.

Do not heat it up or expose it to heat or fire. Doing so will cause fire.

- Please put it out of reach of children.

The cleaning solvent is poisonous. In case if children happen to drink it by mistake, please consult a physician immediately.

### **About the power source**

- When unplugging the power cord, please make sure to hold the plug. If you pull it by holding the cable, the cable may break and cause fire or electrical shock.

### **About installation place**

- Do not put the printer on an unstable or vibrating place.

This may cause body injuries because there is a chance of the machine to fall.

Make sure to put it on a strong and stable table.

- Do not install the machine at a place which is moist and dusty, do not expose it to direct sunlight, high temperatures and fire. This may cause fire or electrical shock.

Please use it at the range of 5- 35 degrees Celsius and humidity of 10 -80% (no condensation).

### **Attention when cleaning**

- When cleaning the device, make sure to turn off the power supply and remove the power cable from the device. Failure to do so may cause an electrical shock.

### **Attention during operation**

- When opening and closing the machine cover, please be careful to your hands and fingers not to be nipped. This may cause serious injuries.

- Do not move your hands or any stuff closer to the machine during operation.

This may cause injuries and problems to the machine.

- Do not put your hands below the cutter during operation. This may cause injuries to your fingers and hands. If there is any problem with the cutter and you need to touch or put your fingers into the machine, please make sure you turn off the printer's power; pull off the plug before doing any work on it. Failure to do so may lead to serious injuries.

### Other Caution

(1) Make sure that the power supply is installed in a vibration-free area without noise and static electricity. If there is a large size home electrical appliance e.g. refrigerator near the printer, the electric voltage may change when the printer is running. This may cause printer failure.

(2) Please do not use an electric tap with other outlets as much as possible because it may cause fire or electric leakage. Also, do not use a long cable between the computer and printer, or between them and a hub, because it might be easy for it to be influenced from noise which will cause device failure and glitch.

## **4. Specification**

<b>Print method</b>	Thermal transfer/Direct Printing
<b>Feeding method</b>	Roller style (Hopper) Roller feeding (Feeding part)
<b>Deleting method</b>	---
<b>Printing dot density</b>	12 dots/mm (approximately 300dpi)
<b>Print speed</b>	80 to 150mm/sec (Standard value)
<b>Paper size</b>	(W)40 to 100mm
	(L)50 to 300mm *Available for specially required size
	Wide type: (W)40 to 130mm (L)50 to 400mm
<b>Paper thickness</b>	0.2-0.8mm
<b>Maximum printing area</b>	(W) 100mm
	(L) 400mm
<b>Hopper capacity</b>	140mm
<b>Font kind</b>	Windows Font
<b>Barcode</b>	JAN8/13,ITF,UPC-E CODE39/93/128, EAN128, NW-7
	QR code, PDF417. etc
<b>Interface</b>	USB, Serial(RS232C), Parallel (Centronics), LAN(option)
<b>Power supply</b>	AC100V/240V
<b>Body size</b>	W378mm×D335mm×H400mm
<b>Weight</b>	20kg

### **Operating Environment for Nice Label (printing software)**

- Pentium based computer with 512 MB of RAM
- 32-bit or 64-bit Windows operating systems: Windows 7, 8
- Hard disk with 75 to 550 MB of free disk space (depending on the installation options).
- CD-ROM drive

### **Connection of the Power Cable**

The power cable is included in option box in carton case. If it was not found by any possibility, please contact us. The power cable included is single purpose for this printer. Please get the power code into the outlet all the way certainly when you use printer. And when you stopped using printer, turn off the power every times and pull out the power code, too.

Also, included power code is supported for each installation area in the world.

If it was mistaken or when you move the printer to another power code area, please contact us.

\* When use ultrasonic cutter, follow the ruled way instructed before. It is special for 100-volt, please install the amplifier between the power source and the printer itself for the case out of Japan. If not use amplifier, the machine will break down inevitably.

### Data transmission cable :

You can use USB, Parallel, RS-232C and LAN (option) cable for Venus series.

#### USB type

USB cable specification is “**USB2.0 Cable A and B**”. Insert A connector into the entry point of personal computer, and B connector into printer main body.

<Recommend: When using SuperRainbow.Net>

- Install print software and printer driver in your personal computer, you can use USB cable. ( You need HASP when sending a print data.)

<The other software including NiceLabel>

- Install FTDI driver when you send a print data through USB cable.

<http://www.ftdichip.com/Drivers/D2XX.htm>

There's in this site, please download “CDM v2.12.00 (\* ) WHQL Certified.exe”

(\* This values mean software version.)

#### Parallel Type

Parallel cable specification is ”**D-sub25 pin (male) — D-sub25 pin (male)** ”.

Port name is “LPT1”.

#### RS-232C Type

RS-232C cable specification is ”(Reverse) • **D-sub 9 pin (female) — D-sub9 pin (female)** ”.

Port name is “COM”.

#### LAN Type

On LAN cable connections, you have to use “**Straight cable**” to connect PC and the printer. You cannot use “Cross cable”. Please use “Straight cable” through to the “Hub” this is called a “**switching hub**”. But remember if it's the old type, it may not be put into use.

Please refer to the diagram below on how to connect.

Printer - Straight Cable - Switching Hub - Straight Cable - Personal Computer

Also, when you use LAN interface, you need to install LANTRONIX Device Driver in your PC.

Please install the file below and contact us when you set up the Lantronix.

[http://ltxfaq.custhelp.com/app/answers/detail/a\\_id/644](http://ltxfaq.custhelp.com/app/answers/detail/a_id/644)

## **5. Parts Name**

(5-1) Front side

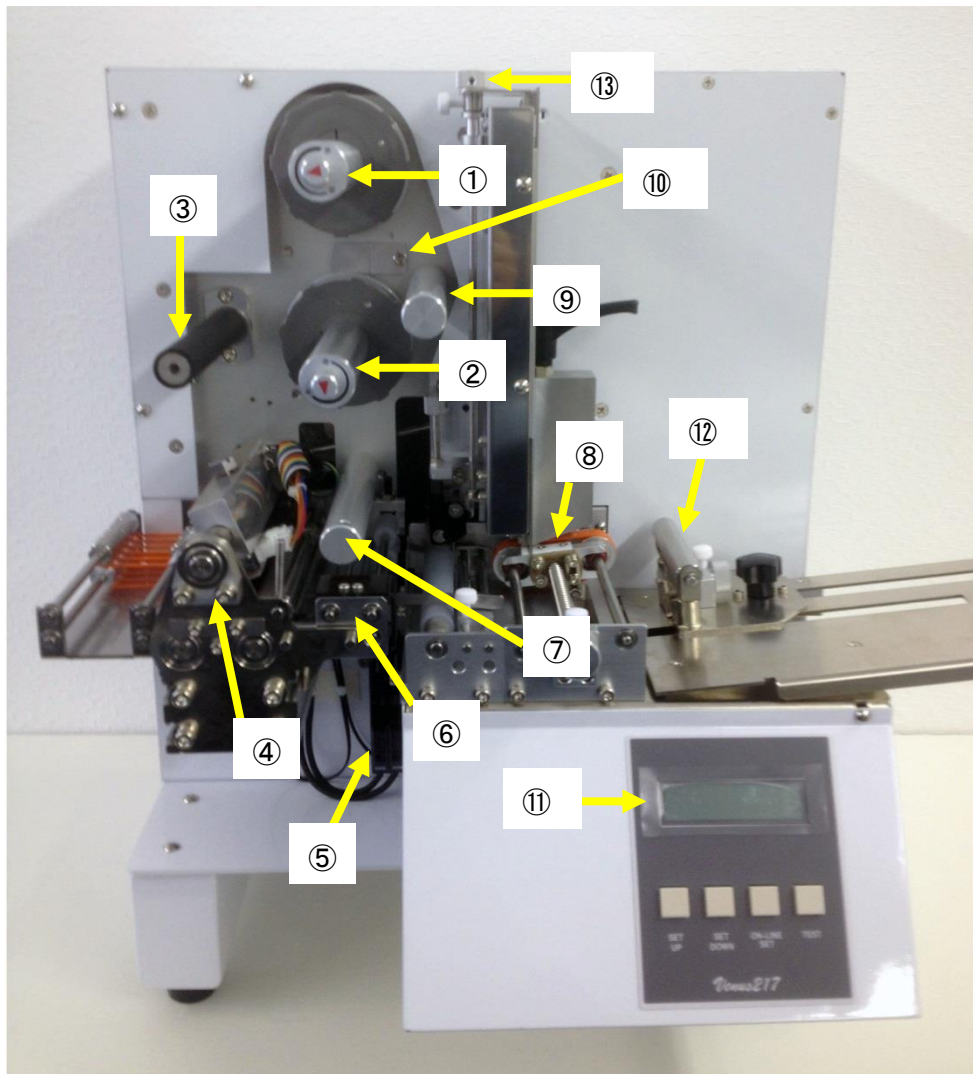

- |   |  |
|---|--|
| ① Supply side Ink Ribbon Axis             | ② Wind side Ink Ribbon Axis              |
| ③ Ink Ribbon Winding Rubber Roller        | ④ Thermal head and platen roller part    |
| ⑤ Paper End and Paper Jam Error Amplifier | ⑥ Feed Roller (4pcs)                     |
| ⑦ Ribbon Shaft (Upper)                    | ⑧ Tag Supply Roller                      |
| ⑨ Ribbon Shaft (Lower)                    | ⑩ Thermal Head Pressure Adjustment Board |
| ⑪ Operation Panel                         | ⑫ Bottom Up Guide (option)               |
| ⑬ Gate Adjustment Screw                   |  |

(5-2) Left side

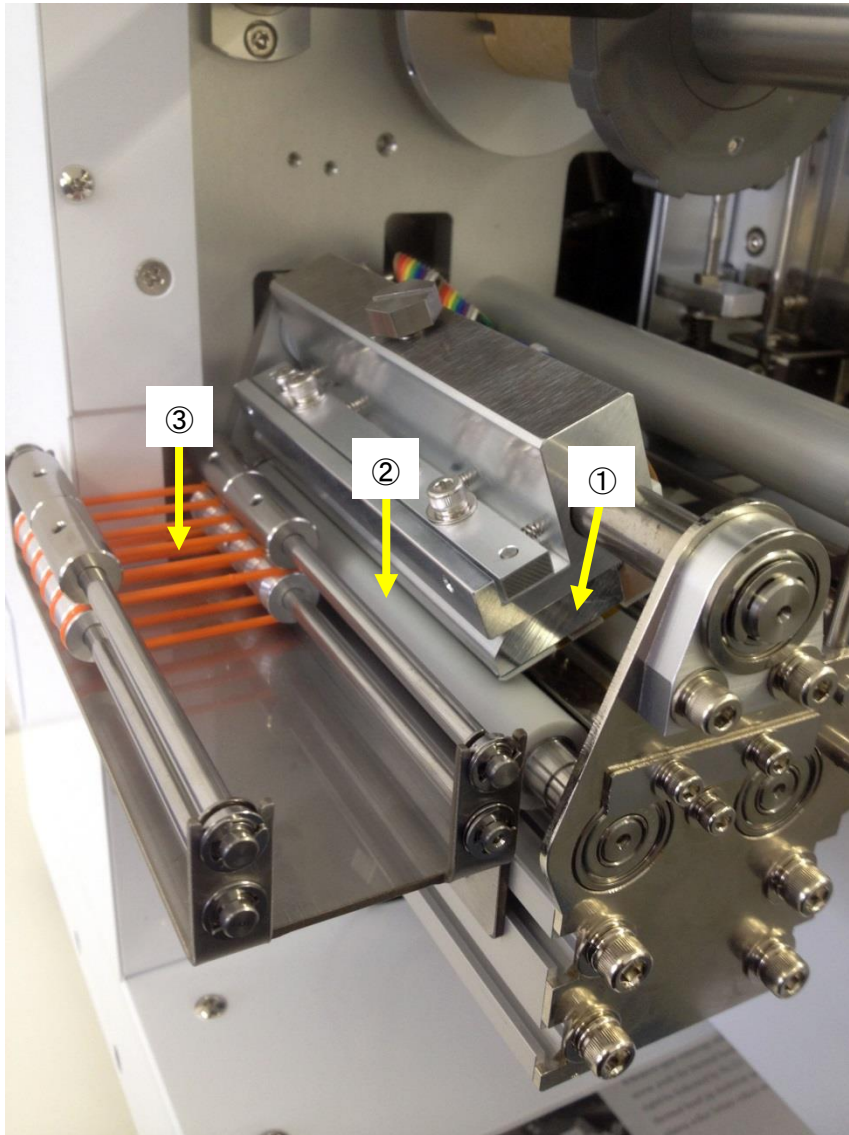

- ① Thermal Head
- ③ Feed Belt

- ② Platen Roller

(5-3) Right side

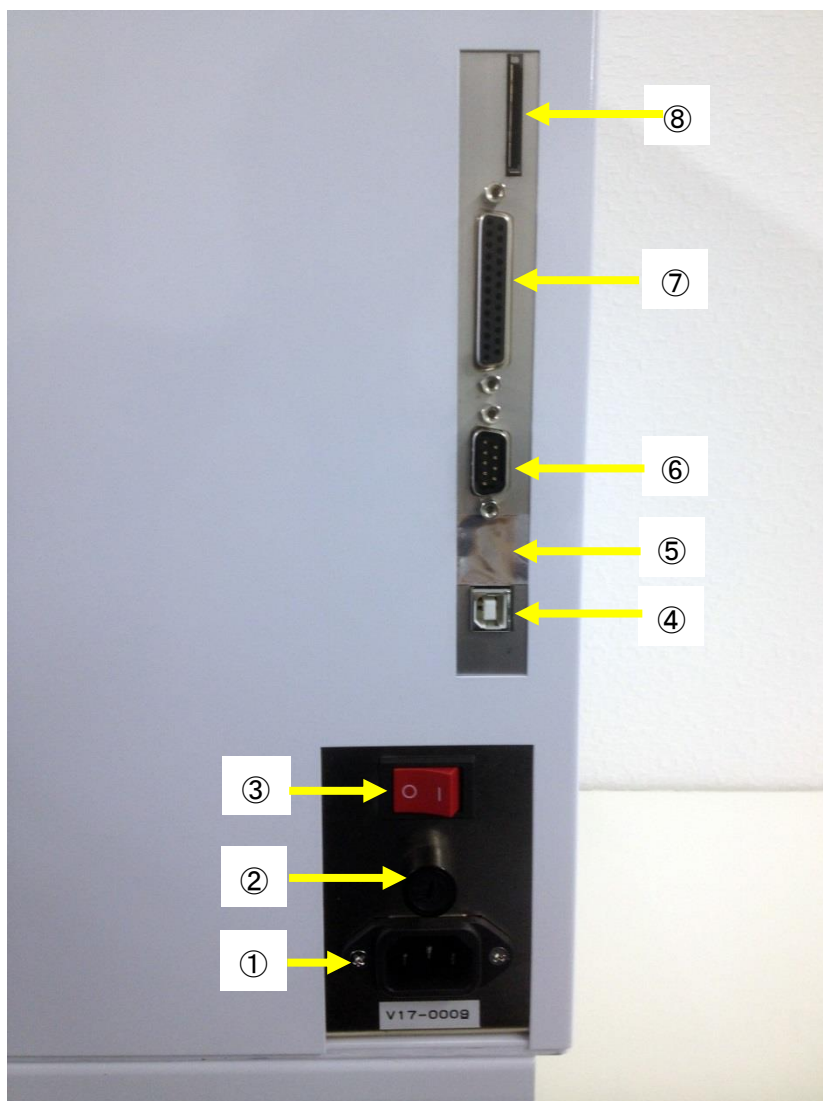

① A/C connector

② Fuse (5A)

③ Power Switch

④ USB Connector

⑤ LAN

⑥ Serial Port

⑦ Parallel Port

⑧ SD Card Insertion Slot

## (5-4) Operation Panel

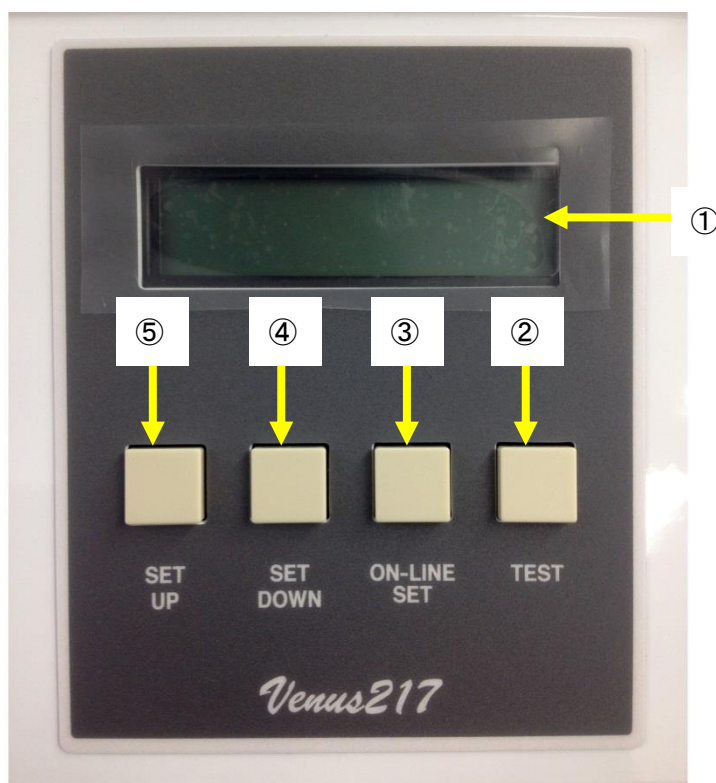

- ① Liquid crystal panel      This displays printer error, condition, setting value and printing counter.
- ② TABLE ↑ Button  
< OFF-LINE >  
    If pushed once the stacker goes up and if pushed again the stacker stops.  
< ON-LINE >  
    Shows total amount of printing value until then. (Disappears after some few seconds)
- ③ TABLE ↓ Button  
< OFF-LINE >  
    If pushed once the stacker goes down and if pushed again the stacker stops.  
< ON-LINE >  
    Displays total running meter of the printer. (Disappears after a some few seconds)
- ④ ON-LINE/SET  
    Use this button when switching the printer to ON-LINE/OFF-LINE, and get into the internal setting mode.
- ⑤ TEST Button  
< OFF-LINE >  
    Pushing this button feeds one piece of tag without printing.  
< ON-LINE >  
    Pushing this button prints same data sent last.



## 6. Ink Ribbon Setting

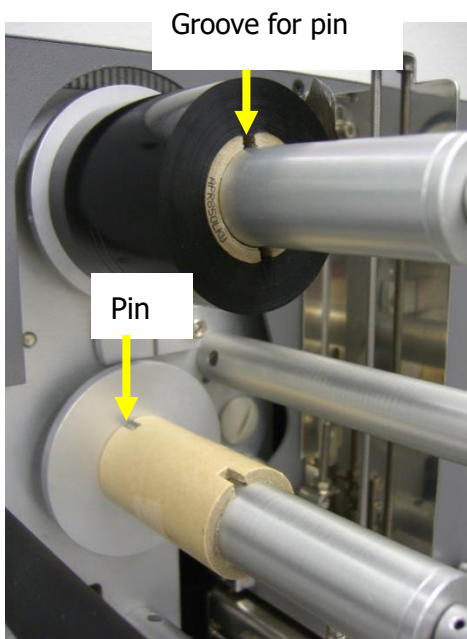
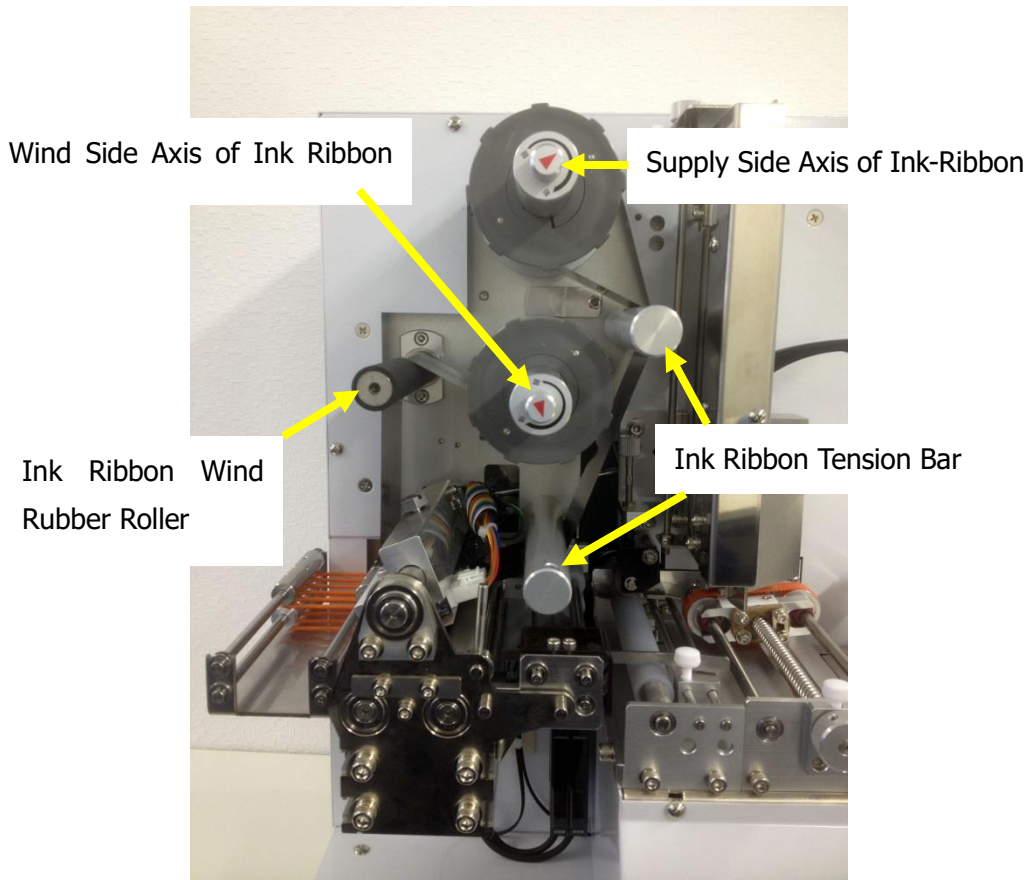

- 1) Set a new ink ribbon on the supply side axis to the end fitting the groove on the carton core of ink-ribbon and the pin on the ribbon guide ring, and set the carton core similarity.

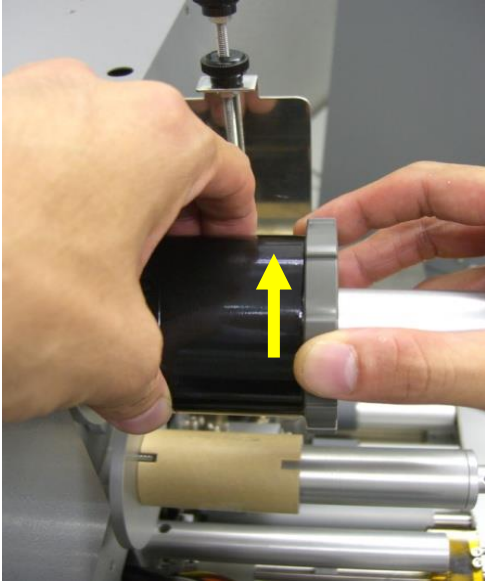

2) Set "One-Touch-Guide" (gray round parts with pin) into the both axis fitting the groove on the carton core and the pin of the one-touch-guide.

3) Turn right the one-touch-guide to lock the ink-ribbon.

4) Set the ink ribbon as seen below; attach the ink ribbon and carton core with tape.

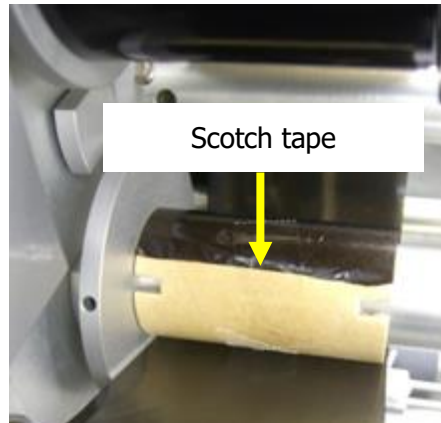

The Venus208 printer can **only be used with inner coated ink-ribbon**. (The ink is coated on the inner side of the ribbon film sheet.)

### How to set a ribbon

 Ink Ribbon

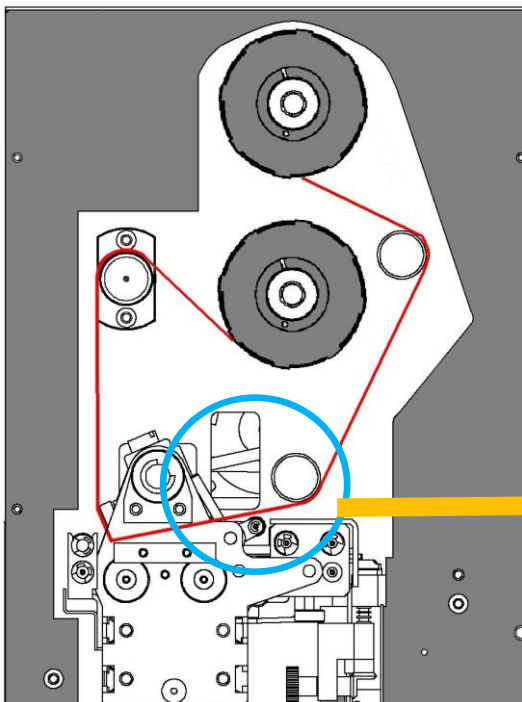

Set the ribbon course through lower side of the ribbon shaft and upper side of small metal roller as seen in the below photo.

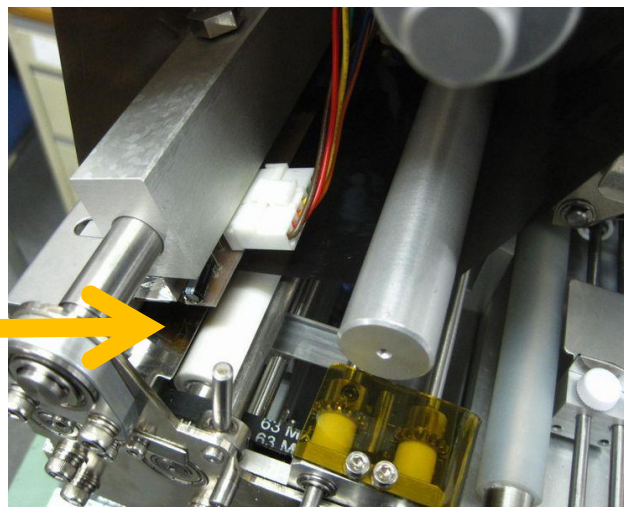



5) Matching a pin and a groove, insert one-touch-guide to the winding side of ribbon shaft and turn it right to lock.

6) Turn the ribbon wind rubber roller clockwise direction until the ink ribbon is tight enough.



Attention : There are two types of one-touch-guide.

With Short pin=Ink ribbon Supply side

With Long pin=Ink ribbon Winding side

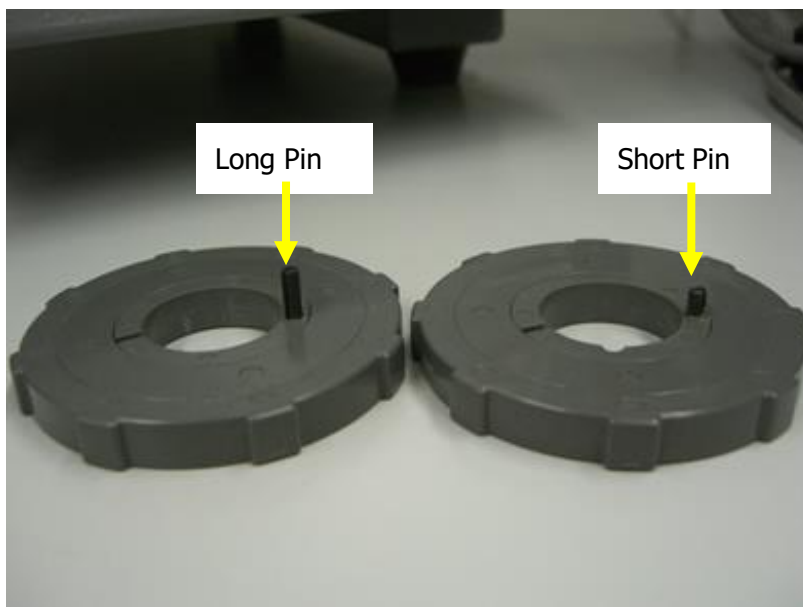

When you attach them in vice-versa, this may cause folding at the edge of the ink ribbon of which may lead to ribbon winding failure.

## 7. Tag Setting

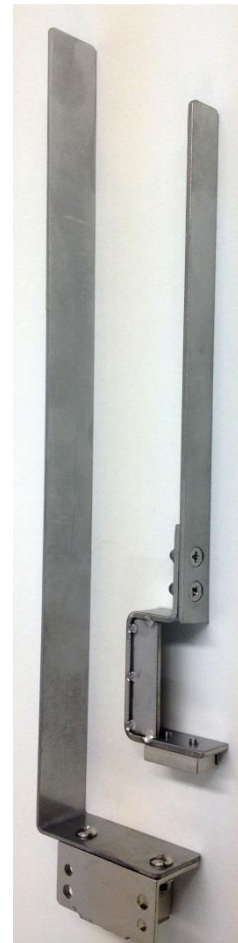
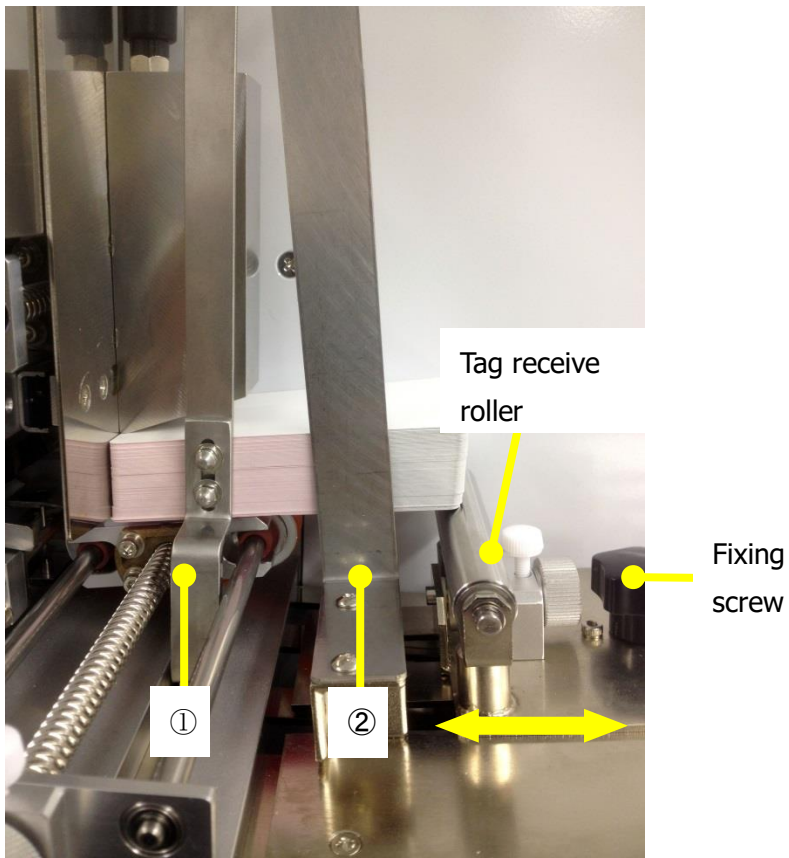

Tag Guide  
(with magnet)

- 1) Set tag and adjust metal roller unit

As seen in the above photo, set tags along with left back wall on the roller.  
When tag is long and it looks unbalanced, attach the "Tag receiver roller"  
at under the end of tag.

- 2) Set the tag guide

Install thin tag guide at ① position and a little thick tag guide at ② position.

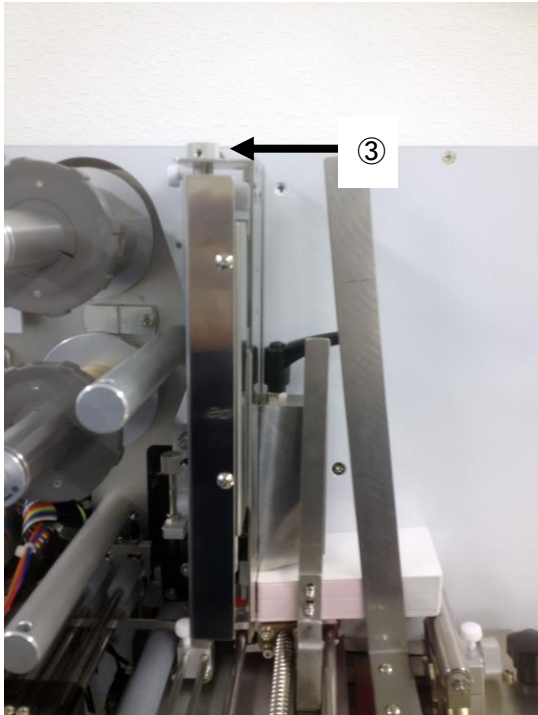

### 3) Adjust gate gap

Tighten or loosen ③ tab screw, you can adjust gate space. Its maximum range is usually available until 0.8mm thickness tag.

### 4) Set and adjust feed support guide.

According to the tag width, adjust the two feed support guides as indicated by the arrow direction.

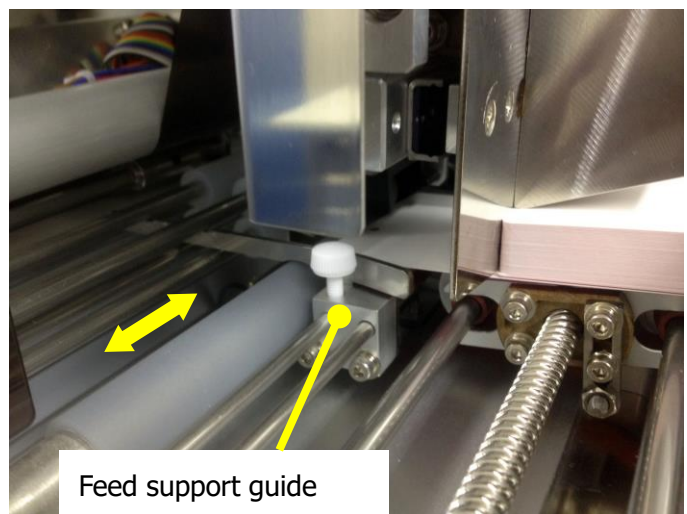

### 5) Align the position by doing feeding test.

When the appropriate position is determined, tighten the fixing screw.

※ When the “tag supply roller” fails to feed the tag, place the option weight on top of the tags.

## **8. Stacker Setting**

### Manual Stacker Plate

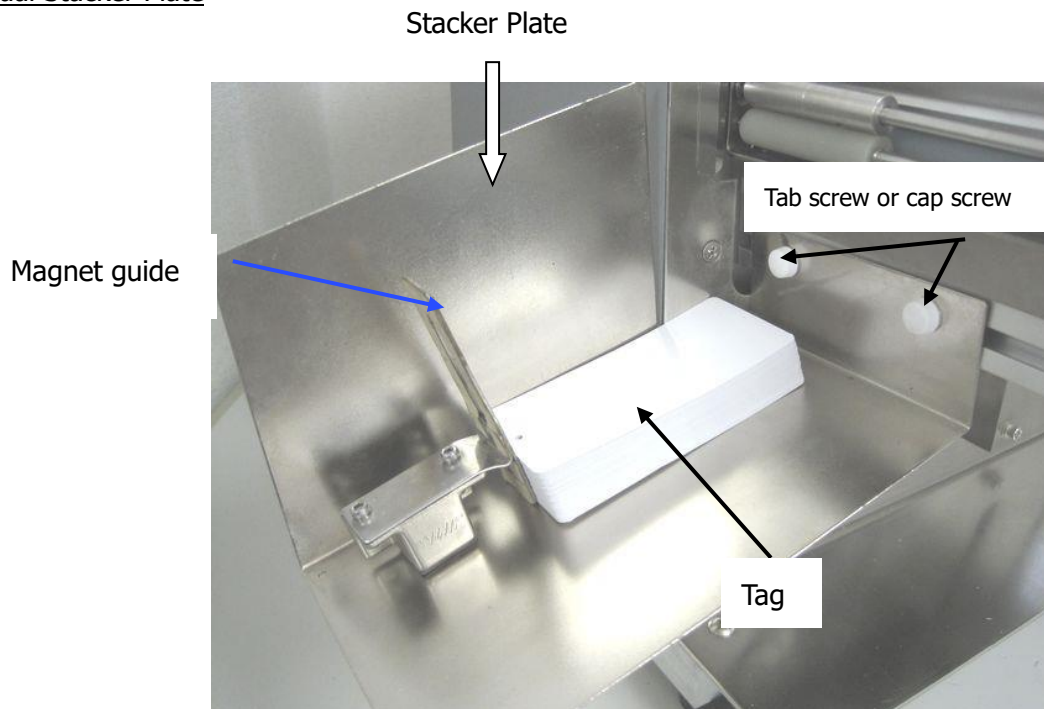

- 1) Fix the stacker plate with two fix screws to the machine main body.
- 2) Put the stopper with magnet on the stacker at an appropriate position to accumulate printed tag.

## 9. Cleaning Machine Parts

Please clean each part regularly.

When cleaning, use a small clean cloth soaked with a cleaner liquid (ethanol or alcohol used for cleaning) .

Make sure to turn off the power of the machine when cleaning it

### <Thermal Head>

(Cleaning the thermal head leads to good printing quality and make the parts durability longer.)

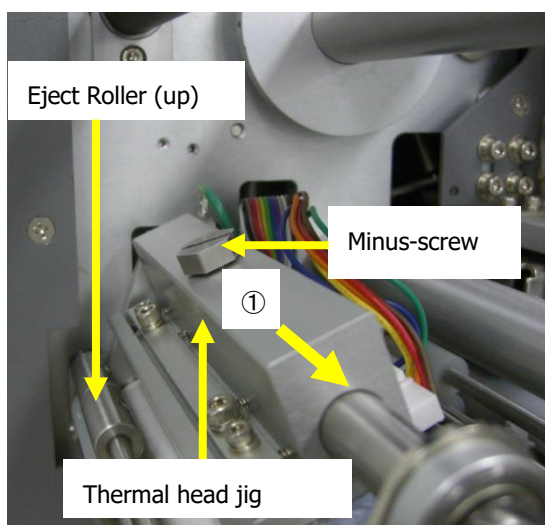

※Remove eject roller(up) and the minus screw, push the thermal head jig to the right (Indicated by No.①). Turn the thermal head unit clockwise and clean the heat element as seen below.

Thermal head heat element is this edge.

Not here

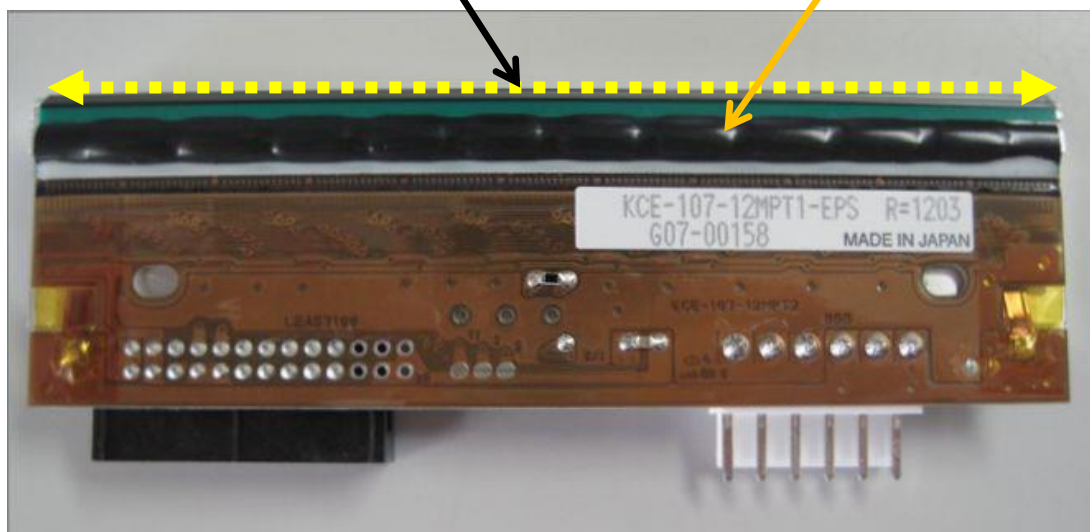

### <Platen Roller>

(Cleaning the platen roller makes printing quality better.)



※Remove eject roller(up) and the minus screw, push the thermal head jig to the right(As Indicated by No.①). Turn the thermal head jig clockwise and then clean the platen roller (white roller) as seen in the left photo.

### • Tag Supply Roller

(Cleaning these rollers frequently makes feeding of the tag smooth)

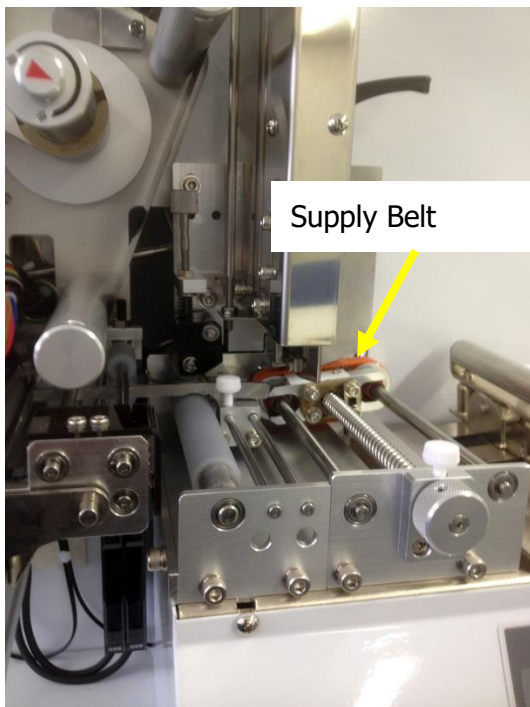



## **10. Error List**

- |                     |  |
|---------------------|--|
| 1) Paper End        | No paper tag or the supply roller is spinning without sending the tags.<br>Add paper tags & then push "ON-LINE" key or push the ON- LINE key to resume printing. |
| 2) Ribbon End       | No ink ribbon or the Ink ribbon was cut on the way.<br>Replace ink ribbon and push "ON-LINE" key to resume printing.   |
| 3) Paper Jam        | Paper tag is stuck within the rollers.<br>Remove paper and push "ON-LINE" key to resume printing.  |
| 4) Cover Open       | Cover is opening.<br>Close cover and push "ON-LINE" key to resume printing.  |
| 5) Stacker Full     | Auto-Stacker table is at the bottom.<br>Remove stacked paper tags and push "ON-LINE" key to resume printing.   |
| 6) Head Jam         | Detection of abnormalities of the printer head movement.<br>Switch- off the power and then re-start.   |
| 7) Illegal Code     | Detection of abnormal data. Check printing data.<br>If the problem is not solved, contact us   |
| 8) No Printing Data | No printing data.<br>Transfer printing data to printer again.  |
| 9) Head Dots Damage | Part of the print head is broken<br>(Only when "Head Check Function" is ON)  |
| 10) Data range Over |  |

## **11. Trouble Shooting**

Whenever a problem occurs during operation, please try the below adjustments.

### **< Adjustment of ink-ribbon tension >**

Problem Case 1. : Ribbon is cut, loose, there are wrinkles on the printed labels.

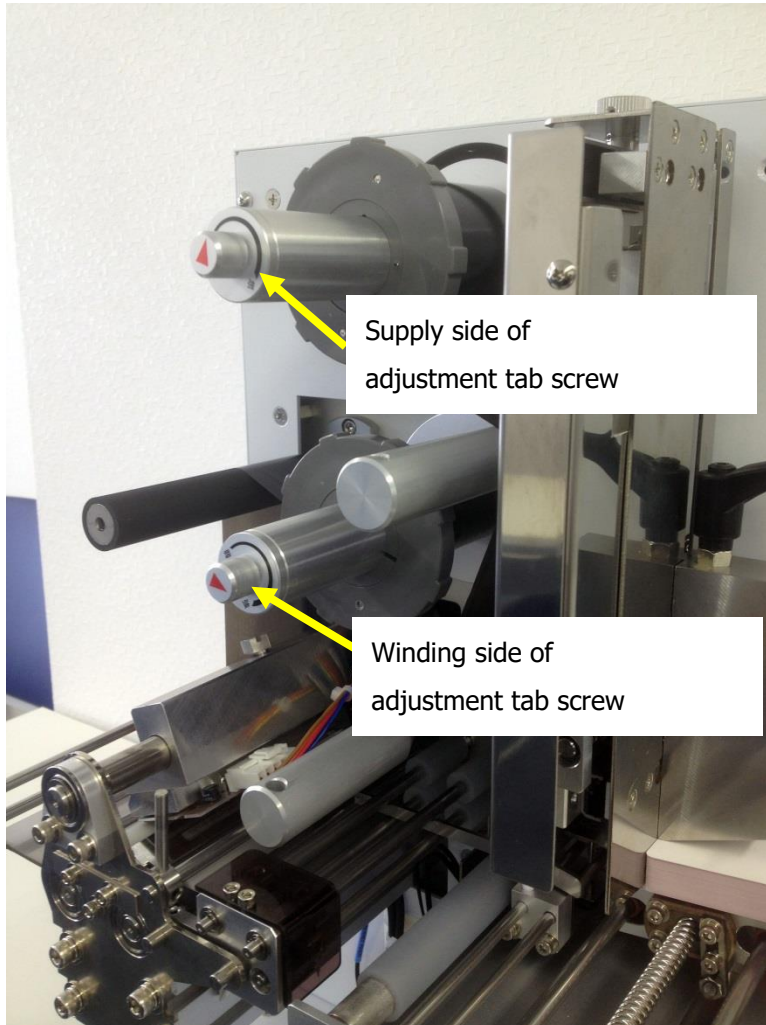

There are tab screws at the top of both the supply and winding axis of the ink-ribbon.

It is possible to adjust the ink-ribbon tension to make it stronger or weaker by turning the screws clock-wise or anti-clock-wise.

#### **Example:**

##### < Supply side >

Turning it into clockwise direction - Ink-Ribbon brake becomes stronger.

Turning it anti-clockwise direction - Ink-Ribbon brake becomes weaker.

##### < Winding side >

Turning it clockwise direction - Ink-Ribbon pulling power becomes stronger

Turning it anti-clockwise direction - Ink-Ribbon pulling power becomes weaker.

※ It is advisable to adjust both side tab screws in order to attain balanced power on both ends.

## < Strengthening thermal head pressure >

Problem Case 2: Poor Printing Quality.

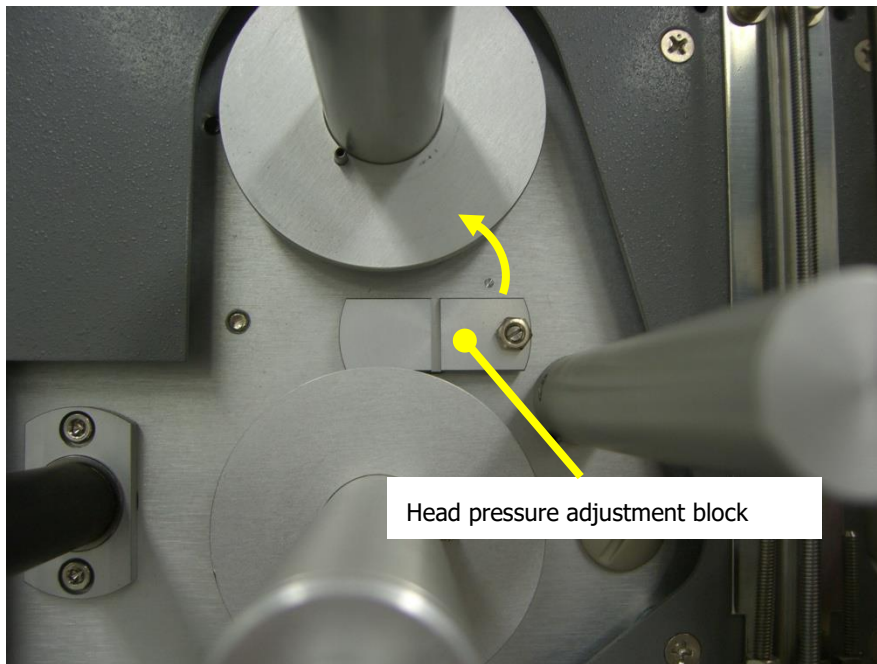

(Default)



(Middle)



(Strong)

It is possible to change the thermal head pressure to three levels, 5.0kg, 5.5kg, and 6.0kg.

(Default) = Horizontal = 5.0kg

(Middle) = 45-degree angle = 5.5kg

(Strong) = 90-degree angle (vertical) = 6.0kg

- ※ Please change the desired head pressure according to the thickness of the tag.  
When the tag's surface is rough and a little uneven, turning the head pressure to strong may solve the poor quality printing problem.

## 12. Panel Setting (v1.88)

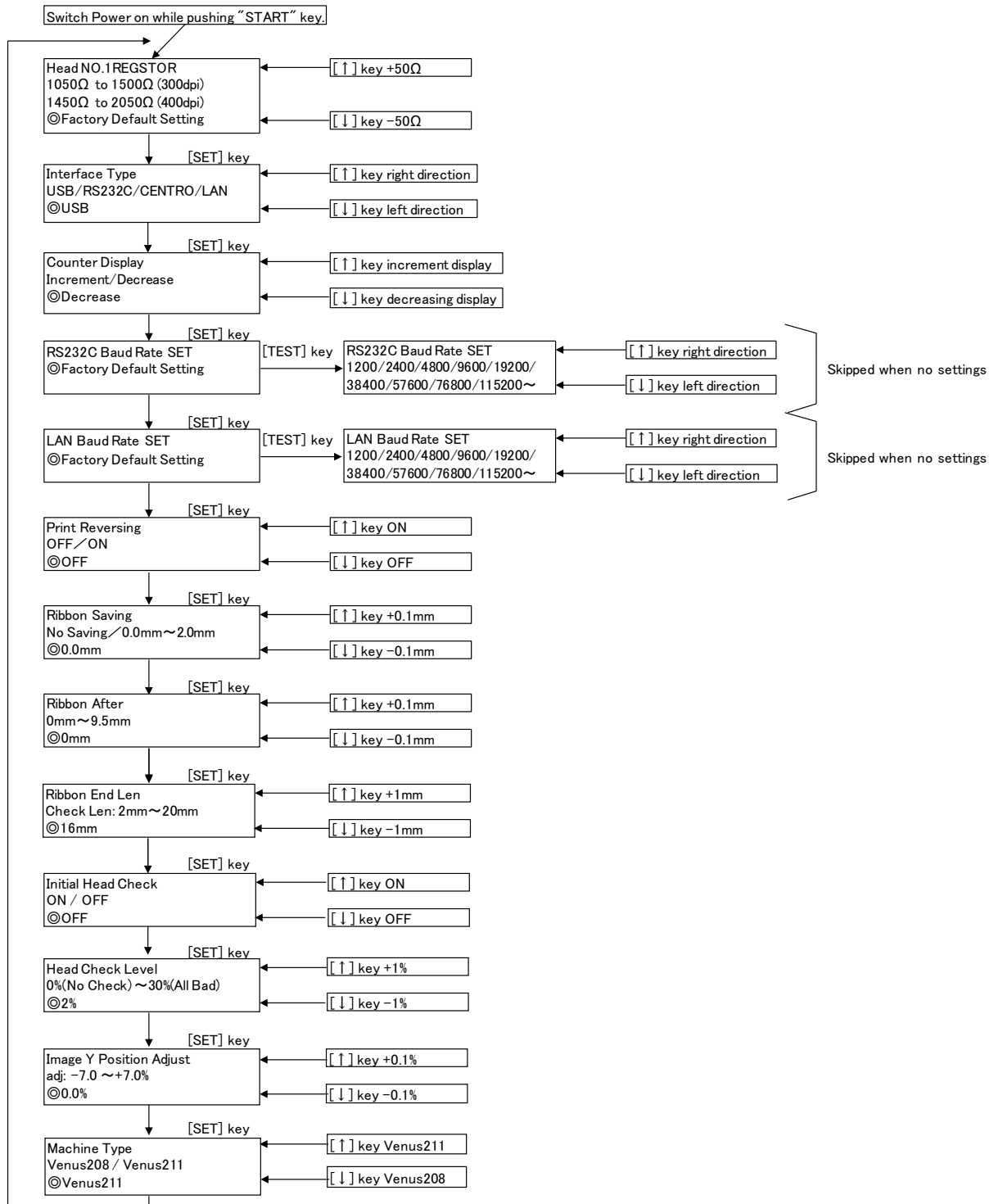

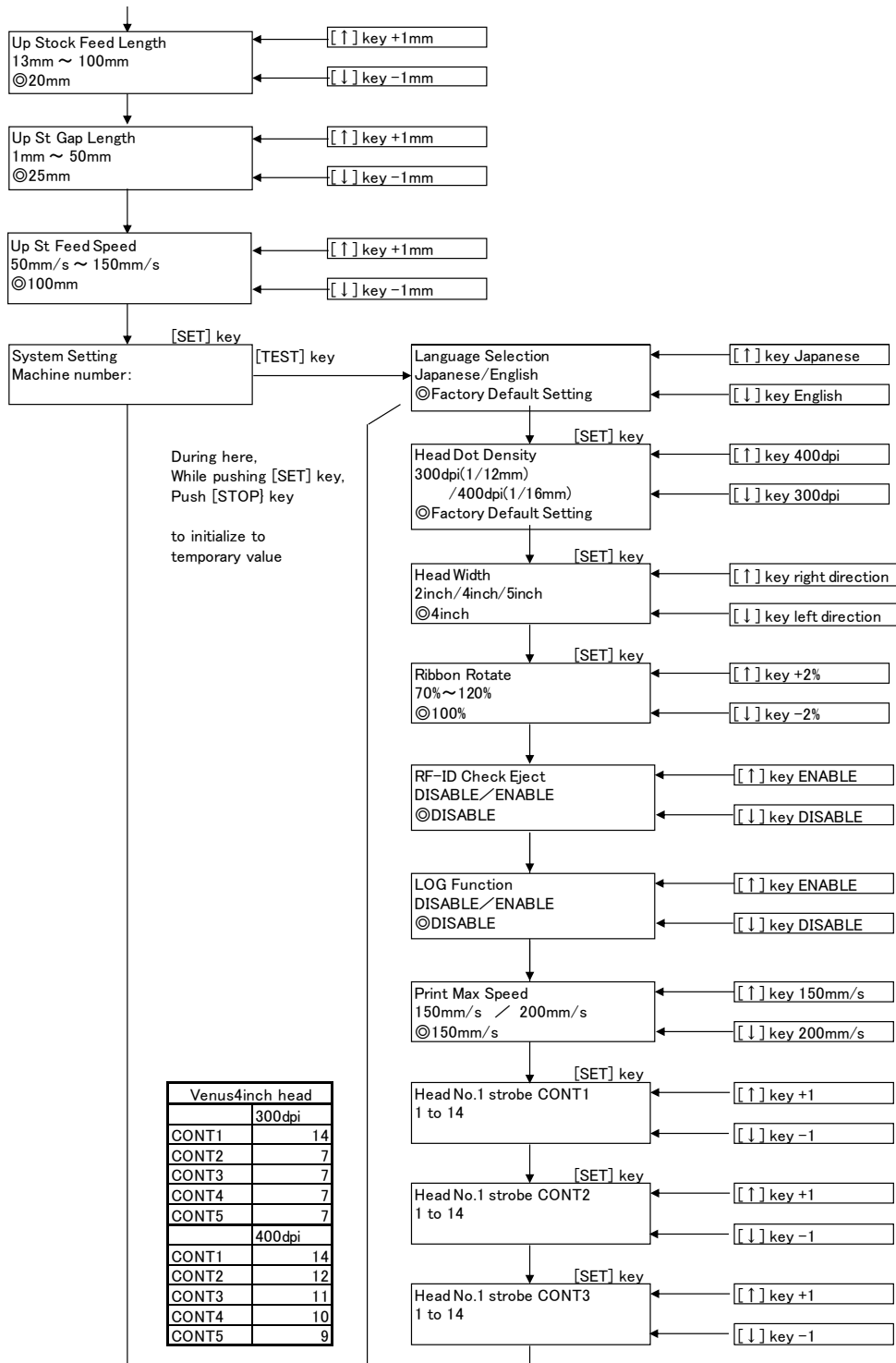

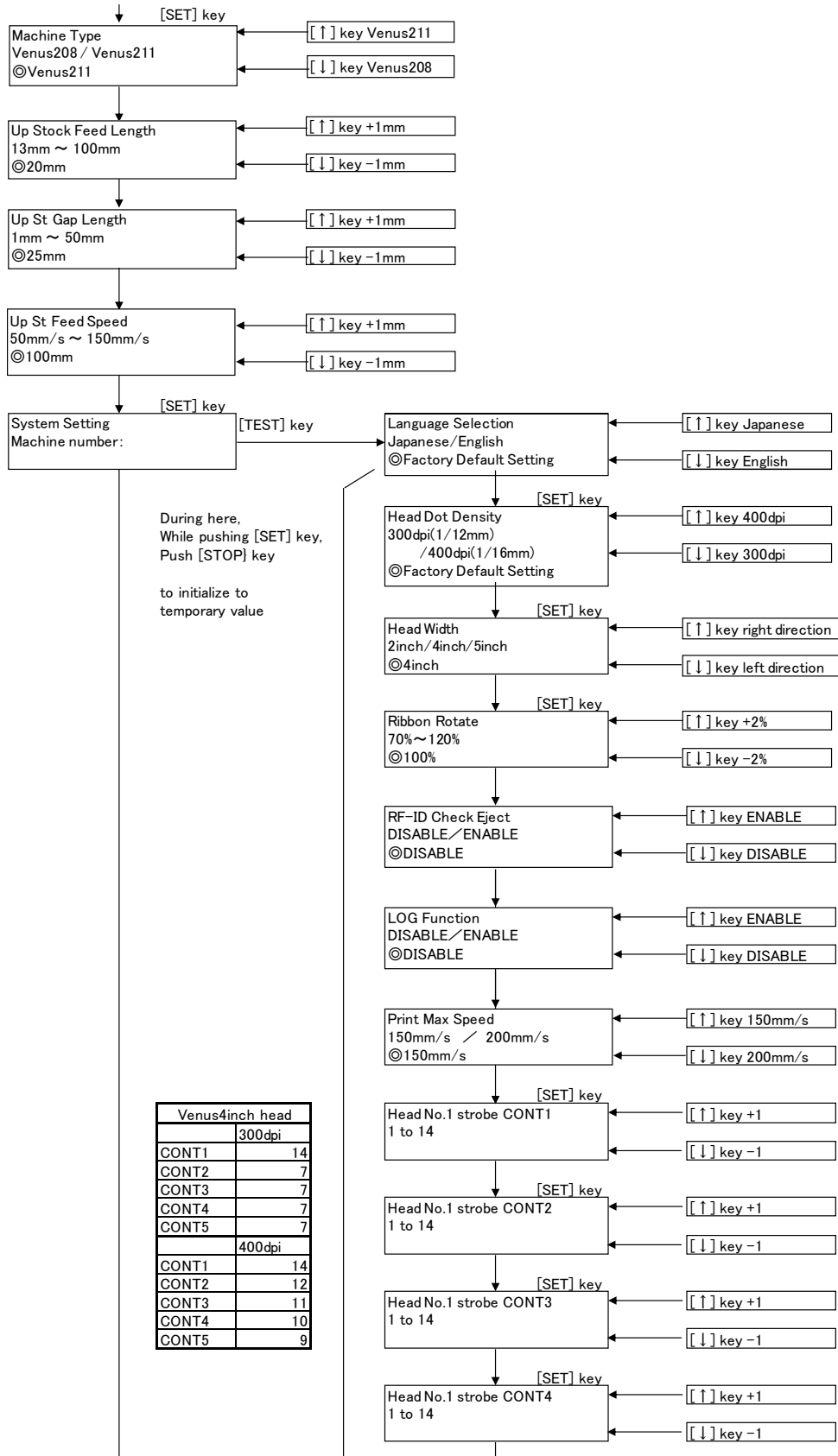

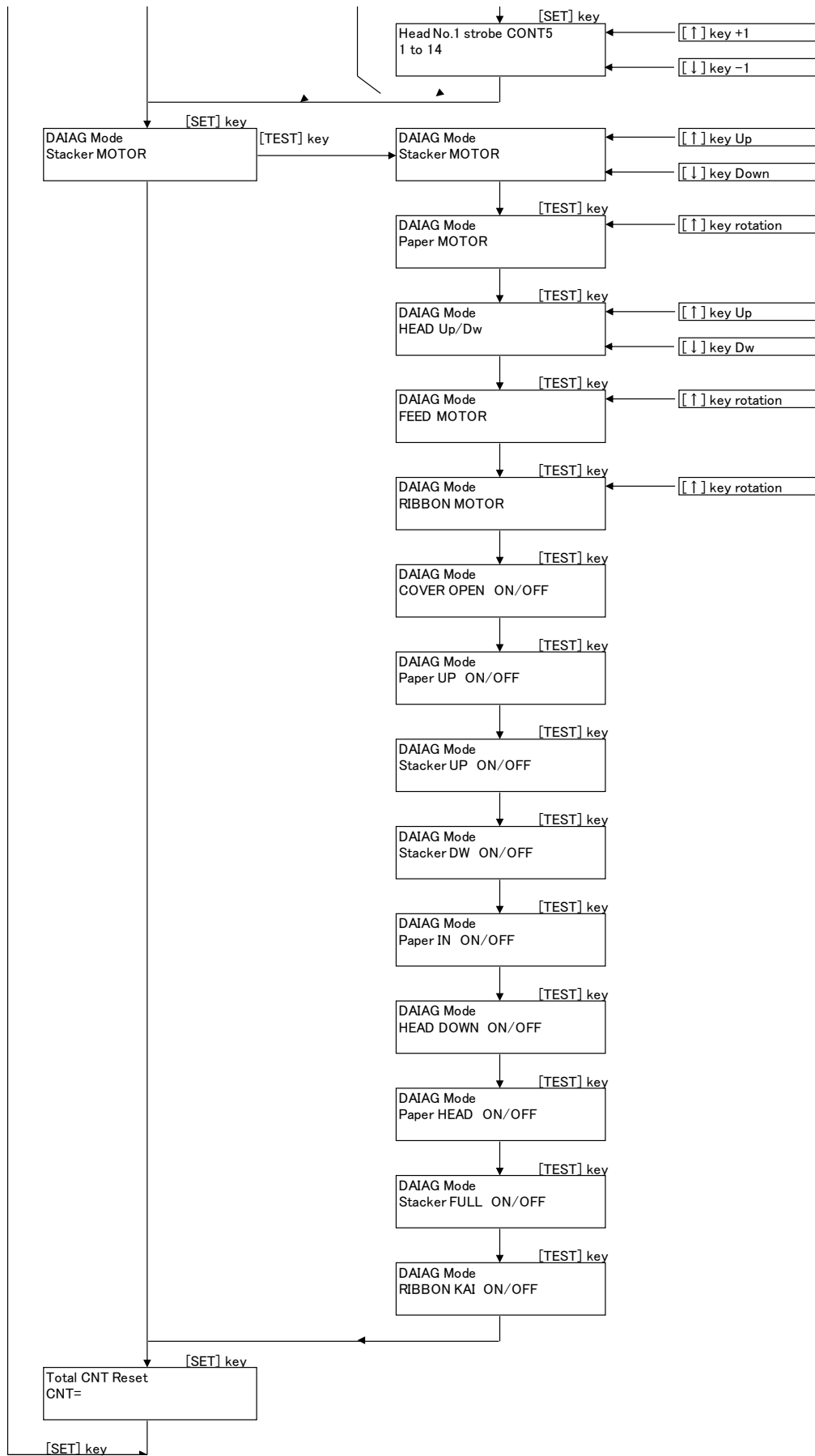

### **13. Internal Setting Instructions** (v1.88)

Turning on the printer while pushing the ON-LINE / SET" button, the printer will change to the internal setting mode which will be displayed on the front display.

\*\*

"TABLE ↑" / "TABLE ↓" Button : Select Button

"ON-LINE / SET" Button : Decision, Switching of term Button

"TEST" Button : Switching Button for System Setting and DIAG(test) mode.

\*\*

Return the printer to normal mode by switching off the main power and then re-start.

(⊙ = default setting)

#### **Head REGISTOR (Resistance)**

1050Ω~1500Ω(300dpi) (↑ +50Ω ↓ -50Ω)

1450Ω~2050Ω(400dpi)

⊙factory default setting

Please always make sure to re-set to the appropriate "Head Resistance" every time the thermal head is replaced.

(Failure to re-set the correct head resistance after changing the thermal head will affect the life span of the new printer head)

#### **Interface Type**

I/F : USB / RS232C / CENTRO / LAN

⊙USB

#### **Counter display**

Increment / Decrease

⊙Decrease

You can select counter type of increment or decrease when printing.

#### **RS232C baud rate SET**

(Skip when no settings)

1200 / 2400 / 4800 / 9600 / 19200 / 38400 / 57600 / 76800 / 115200~

⊙factory default setting

#### **LAN baud rate SET**

(Skip when no settings)



1200 / 2400 / 4800 / 9600 / 19200 / 38400 / 57600 / 76800 / 115200~

Ⓒfactory default setting

### **Print Reversing**

OFF / ON

ⒸOFF

This is a function which it's possible to change the printing direction opposite (180 degree).

### **Ribbon Saving**

No Saving / 0.0mm~1.0mm ( ↑ +0.1mm ↓ -0.1mm)

Ⓒ0.0mm

With this function it's possible to save the amount of the winding Ink Ribbon used to print on every piece of tag.

When "No Saving", is set the print head does not move up during printing. When you set to "0.0mm", the print head will move up after printing every single tag hence saving the ink ribbon used.

Using this function to print on tags with treated material or treated surface may cause poor printing effect.

### **Ribbon After**

0mm~9.5mm ( ↑ +0.5mm ↓ -0.5mm)

Ⓒ0mm

This is the timing of moving up of the thermal head after printing one piece of tag.

If a black line or wrinkles are printed on the bottom of the tag of a treated surface tag material, please change this value.

### **Ribbon End Len (ribbon end detection)**

2mm~20mm ( ↑ +1mm ↓ -1mm)

Ⓒ16

This is the sensor accuracy degree to detect ribbon-end.

When the tag is long but the print data is printed on a small area of the tag, or the print data has only one line or two, it will not be enough to wind ink ribbon which can be detected by the sensor. So this may cause ribbon end error, even though the ribbon is not finished. In such a case, please change this value.

### **Initial Head Check**

ON / OFF

ⒸOFF

Head Check function is to check and detect if thermal head heat element is broken or not.

When the heat element is broken, white vertical line appear during printing. Even if part of the heat element is broken, it is possible to print data. But if printing "barcodes", one has to be careful because

there is a possibility of the printed barcodes not to be read properly by a barcode reader.  
When this function is selected and set to ON, the printer will always do print head check function.

### **Head Check Level**

0%(No Check)~30%(All Bad) (↑ +1% ↓ -1%)

◎13%

This is for the sensor degree of accuracy to detect how far the head heat element is broken.

### **Image Y position Adjust**

adj: -7.0~+7.0% (↑ +0.1% ↓ -0.1%)

◎0.0%

It is possible to adjust the printing data position vertically (Y position). Until the platen roller is completely worn off and according to the thickness of the tag. There may be some slight differences on the image on the PC software and the actual printing position.

### **Machine Type**

Venus208 · Venus211

◎Venus211

### **Up Stock Feed Length**

13mm~100mm (↑ +1mm ↓ -1mm)

◎20mm

This is for setting of the tag feeding distance (time) which is effected by rotating the supply rollers.  
When printing on a long tag, please increase this value.

### **Up Stock Gap Length** (↑ +1mm ↓ -1mm)

1mm~50mm

◎10mm

This is for setting of the gap between the end of the first tag and the beginning of the second tag.

### **Up Stock Feed Speed** (↑ +5mm/s ↓ -5mm/s)

50mm/S~100mm/S

◎100mm/S

This is for setting the feed test speed.

### **Up Stock Retry Value**

No retry / 1 / 2 / 3

Ⓒ 1

This is for setting the number of retrying of the tag's supply, when a miss occurs during feeding of the tag.

### **System Setting**

The Machine Number :

The first numbers are the machines serial number, while the last numbers are the date of production of the printer's main board.

### **Language selection**

Japanese / English

Ⓒfactory default setting

### **Head dot density**

300dpi (1/12mm) / 400dpi (1/16mm)

Ⓒ300dpi

### **Head width**

2inch / 4inch / 5inch

Ⓒ4inch

### **Ribbon Rotate Rate**

70%~120% ( ↑ +2% ↓ -2%)

Ⓒ100%

With this function, the power (amount) of winding ribbon can be adjusted. If the ink ribbon is cut easily, adjust and reduce the power of the winding ribbon. Or if, some wrinkles are printed during printing please adjust and strengthen the power of the winding ribbon.

### **RFID- Check Eject**

DISABALE / ENABLE

ⒸDISABALE

### **Head No.1 strobe CONT1**

1~14

Ⓒ14

### **Head No.1 strobe CONT2**

1~14

◎7

### Head No.1 strobe CONT3

1~14

◎7

### Head No.1 strobe CONT4

1~14

◎7

### Head No.1 strobe CONT5

1~14

◎7

The Head strobe rule is first No.1 the strobe should be set to the highest value (around 14-1). Please set the value in a gradual degreasing order e.g. "14, 10, 9, 8, 7" this is an example.

However settings like "14, 7, 7, 7, 8", should be avoided, similar settings will contribute to early breakdown of the thermal head and main board. It's advisable to set the lowest value of CONT5.

### DAIAG Mode <Driving check mode> (with TEST button into this mode)

Stacker MOTOR    ↑ UP    ↓ DOWN

It's possible to check the driving of stacker (table) motor.

Paper MOTOR        ↑ Rotation

It's possible to check the driving of supply (roller) motor.

HEAD Up/Dw        ↑ UP    ↓ DOWN

It's possible to check the driving of head up/down motor.

FEED MOTOR        ↑ Rotation

It's possible to check the driving of feed motor.

RIBBON MOTOR    ↑ Rotation

It's possible to check the driving of ribbon wind motor.

COVER OPEN    ON/OFF

It's possible to check the behavior of cover sensor. (by trying to cover the sensor)

Paper UP    ON/OFF

It's possible to check the behavior of tag set part sensor.  
(this may not work, up to the printer's lot number)

#### Stacker UP ON/OFF

It's possible to check the behavior of the auto-stacker upper limited sensor.

#### Paper IN ON/OFF

It's possible to check the behavior of paper end sensor.  
(by trying to cover the sensor, you'll find to switch ON/OFF on machine's display)

#### HEAD DOWN ON/OFF

It's possible to check the behavior of head up down sensor.  
(This is near the head up/down motor)

#### Paper HEAD ON/OFF

It's possible to check the behavior of paper jam sensor (under the head part).

#### Stacker FULL ON/OFF

It's possible to check the behavior of stacker full sensor of auto-stacker.

#### RIBBON KAI ON/OFF

It's possible to check the behavior of ribbon end sensor.

#### CS0 : ff00

It's possible to check the behavior of ↑ button and ↓ button.

#### Total CNT Reset

CNT= this is total counter.

## 14. How to Clear Print Data Without Turning off the Power

Please follow the below step when you want to clear the data you already sent to the printer without turning off power source.

Resent condition

“OFFLINE” + “Tag Set Table is at the top” + “Push ↑ key for over 4 seconds”

## 15. How to Update Printer Firmware

Procedure

1. Prepare “SD-card” of SDHC (SD High Capacity) standards and put one file of firmware “MERCURY.BIN” for the version update in your SD-card on PC.



※Active certification of SD-card on this printer is until 2GB. We haven't guaranteed over 2GB SD-card. Please don't rewrite firmware with over 4GB SD-card.

( Don't change the file name. If changed the name, the printer hardware could be broken)

2. Insert the SD-card which has the firmware into the slot on the side of the printer.



※Insert the SD-card into the slot as indicated by the arrow. Fix the power code to the printer's main body, and turn off the power.

3. While pushing the three buttons "TABLE ↑" + "TABLE ↓" + "TEST" at the same time, switch on the printer power while still to pushing the three buttons.

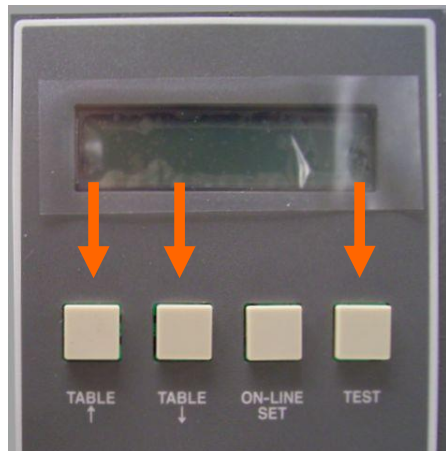

4. "System Boot" will be displayed, please make sure to confirm how long the counter value will rise. Then, release the buttons.



5. Lastly "UPDATE SUCCESS" will be displayed. Please confirm whether the firmware is updated. If not, try it again.



In case of any Inquiries, Questions or Requests, please contact your dealer or us through the following email address.

575 Prospect St., #211  
Lakewood, New Jersey 08701-5073  
Tel: 732.367.3100



fax: 732.367.7031  
e-mail: [sales@dalemark.com](mailto:sales@dalemark.com)  
website: [www.dalemark.com](http://www.dalemark.com)

