

Operation Manual

Venus

Single Tag Printer

575 Prospect St., #211
Lakewood, New Jersey 08701-5073
Tel: 732.367.3100



fax: 732.367.7031
e-mail: sales@dalemark.com
website: www.dalemark.com



Contents

Introduction

1. Unpacking	2
2. Introductions for Use	3
3. Safety Precautions	5
4. Specification	11
5. Part Location & Part List	13
(5-1) Front view (5-2) Rear view without cover (5-3) Part list	
(5-4) Right side view (5-5) Control Panel & Button Instruction	

Setting

6. Setting of Ink-Ribbon	17
7. Setting of Tag	19
8. Setting of Simple Stacker and Auto Stacker	20
(8-1) Simple Stacker (8-2) Auto Stacker	

Adjustment

9. Adjustment of Ink Ribbon Tension	23
10. Adjustment of Gate (Gap adjustment)	24
11. Adjustment of Thermal-Head Pressure (A) / (B)	25
12. Adjustment of Thermal-Head Position	27

Cleaning

13. Clean Part	28
14. How to Clean Thermal Head / Platen Roller	29

Replacement

15. How to Replace Thermal Head	32
16. How to Replace Platen Roller	34
17. How to Replace Stopper	36

Appendix

18. Error List	38
19. Panel Setting	39
20. Internal Setting Instruction	42
21. How to Clear Print Data Without Turning off the Power	47
22. How to Update Printer Firmware	47

Introduction

Thank you for purchasing our single tag printer "Venus208"

Please read this user manual beforehand for your proper use of the printer, and keep this manual with you after reading.

1. Unpacking

Please check the carton case carefully and make sure that there are no serious damages or dents on the box.

If you find any damages on the device when unpacking, please contact your vendor immediately.

 ATTENTION	Printer is so heavy. Don't move alone, but unpack with over a few people.
--	--

When you lift the printer main body from the carton case, please check there is enough large space without any trash on the floor, and have your hands at the bottom of the machine, get out it slowly, carefully not to injure your body. If you'd lift forcedly or manhandle it, may lead big accident.

Followings are the items included.

Operation manual	1
Magnet stopper	1
Hexagon driver (M2.5)	1
Flathead screwdriver	1
Carton core	1
Power code	1
USB cable / LAN cable	1
One-touch guide	2
Cleaning kit	1

Included power code is single purpose for this printer. Please don't use included power code in the carton case to another machine. It might cause of fire and electrical shock.

2. Instructions For Use

For the safe use:

This printer is designed and manufactured carefully for your safety, it is imperative, however, that following safety instructions are fully understood and put into practice. Please read the following instructions carefully for your proper usage of the devices.

 Warning	Indicates that failure to follow directions in the warning could result in serious bodily harm.
--	---

(Unpacking, installation, and transporting)

- ⦿ The printer is heavy. Take hold of the device from the bottom and lift it out the box carefully.
- ⦿ Install the printer on the solid and strong table.
- ⦿ Place the printer in the center of a table. If not, there is a possibility of dropping out of the table.
- ⦿ During operation, pay careful attention to your fingers not to get them caught in the devices. Please be careful when dealing with the devices.

(Maintenance, inspection, and adjustment)

- ⦿ Please make sure that your printers and computers are turned off and that the power strip is unplugged when conducting maintenance, inspection, and making adjustment.
- ⦿ Do not plug in and out with undried hands. Failure to follow this instruction could result in getting you an electric shock or injured.
- ⦿ Do not make alterations on equipment or disassemble the parts of the devices unless directed to do so. Failure to follow this instruction could result in ignition or malfunction of the equipment, which might cause your body injured.
- ⦿ Please wipe out carefully if you find dust and dirt on the edge of the power connector or its interface. If not, it might cause ignition.

 Caution	Indicates that failure to follow directions could result in minor or moderate bodily injury or in damage to equipment.
--	--

(In operation)

- ⦿ Do not touch the rollers in operation.
- ⦿ Do not touch the pulse motor inside the printer in operation. Failure to follow this direction could result in getting your body injured or barn

(Changing the ink ribbons)

- ⦿ Be careful when handling the thermal head since it is very hot after use. It might cause you barn injury.

(Cleaning and changing the thermal head)

- ⦿ Make sure that the power switch is turned off.
- ⦿ Please be careful when handling the thermal head after switching off the device because it is very hot for a while. Failure to follow this instruction could result in getting you an electric shock or injured.

(Cleaning the thermal head, platen roller, and sensor device)

- ⦿ When cleaning the thermal head, the platen roller, and the sensor, you are required to use isopropyl alcohol, methanol or ethanol. Do not use other agent for cleaning. Failure to follow this instruction could result in damage to equipment.
- ⦿ Be careful when handling isopropyl alcohol and methanol since they are flammable.
- ⦿ Avoid cleaning the thermal head when it is hot. Failure to follow this instruction could result in ignition of equipment.

3. Safety Precautions

■Foreword

Before using this product, be sure to read and understand this SAFETY PRECAUTIONS and Operation Manual carefully.

Also please store this operation manual beside the main body with caution to read no matter when you use this product.

■Meaning of Pictorial Indication

This manual provides some attention terms with pictorial indications for use product safety.
Please read following terms.



A warning notice indicates contains which could result in death or serious injury of the users, if they treat in wrong and unheeded without special attention



A caution notice indicates contains which could lead to bodily injury or material damage, if they treat in wrong and unheeded without special attention.

Example of pictorial indications



Symbol indicates content that provides attention.
A concrete attentive content is drawn in the graphic.



Ex. Electric shock hazard



Symbol indicates prohibited term.
A concrete prohibited content is drawn in the graphic.



Ex. No decomposing



Symbol indicates instruction term.
A concrete instruction content is drawn in the graphic.



Ex. Pull the outlet

Be sure to conform following attentions for the safety use. Also do not treat out of the way of use without this manual. It could cause to an accident, fire and electrical shock.

About the power source

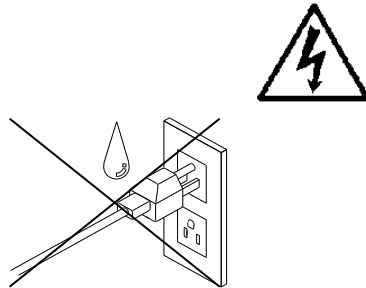

- Do not plug in and out with undried hand.
It causes electrical shock.

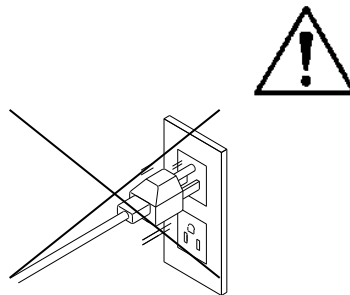

- Please all the way pushed power code into the outlet for sure.
If it would be skimp, causes fire and electrical shock.

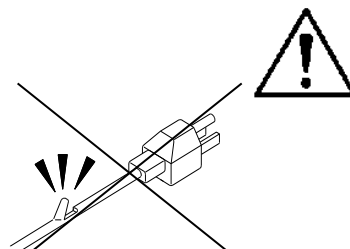

- Do not use injured cable and loosen outlet.
If it would be used as it is, may cause it short, fire and electrical shock.

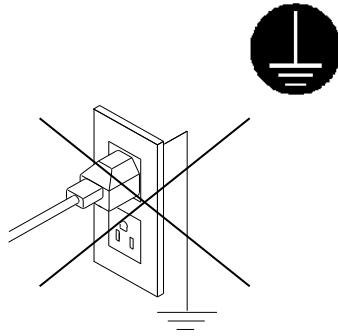

- Be sure to use earth cable connecting.

If the earth cable does not connect the earth, it causes electrical shock.

If abnormality occurs by any chance

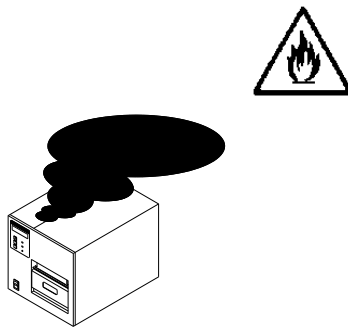

- If anything abnormality occurs like smoke or nasty smells rise and you keep to use it as it is, it causes fire and electrical shock. Promptly turn off the switch and pull the power code out, and please contact us.

Others

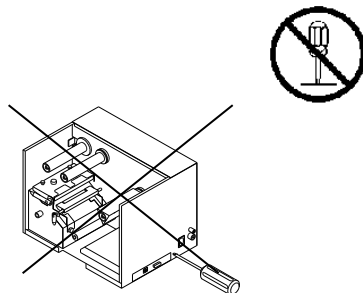

- Do not dismantle nor remodel the machine.

Inside of the machine has a part of high electric voltage, it causes fire and electrical shock.

If it needs maintenance and repairing, please contact the dealer you purchased or our service window.

About cleaning liquid

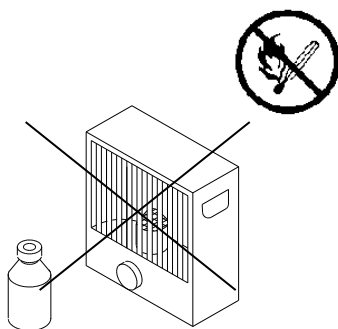

- Cleaning liquid is an inflammable solvent.

Do neither heat up nor put it near the fire. It causes fire accident.

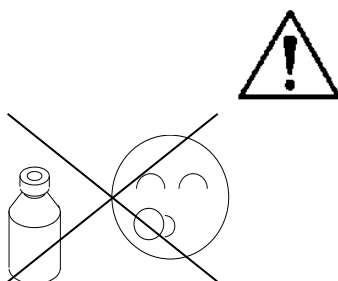

- Do not put it at the place children's hand reach.

If they drink it by mistake, that is very dangerous. If they drink it by any chance, please consult with a doctor near you as soon as possible.

About the power source

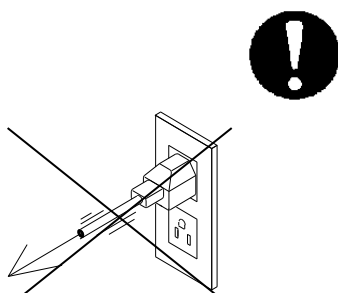

- When you pull out the power cord, please be sure to hold the plug. If you pull it holding the cord, it may be injured and causes fire and electrical shock.

About installation place

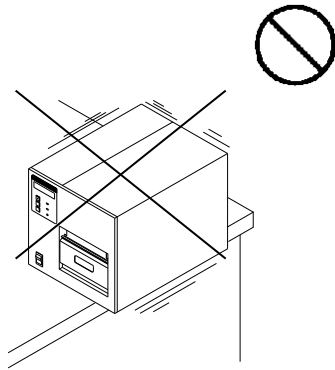

- Do not put the printer on a wonky or vibrating place.
It may cause your body injured if the machine come down or fall over.
Be sure to put it on a solid and strong table.

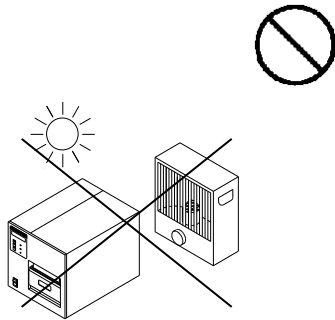

- Do not install the machine at the place of much moist and dust, exposing to direct sunlight, high temperature and fire. It may cause fire and electrical shock.
Please use it at the range of 5 ~ 35 Celsius degree and humidity is 10 ~ 80% (no condensation).

Attention when cleaning

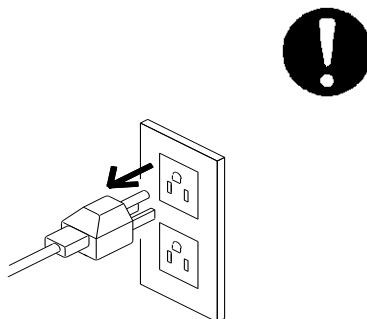

- When cleaning, be sure to turn off the power switch and pull out the power code from the outlet. It may cause short and electrical shock.

Attention under operation



- Please be careful not to be nipped your hand and finger, when you open and close the machine cover. It may cause injury.



- Do not move anything like your hand and stuff closer to machine during operation. It may cause injury of your body and failure of the machine.

Other Caution

(1) Make sure that power supply is installed in vibration-free area without broad-noise and static electricity. If there's a large size of home electronics like refrigerator near the printer, the electric voltage may change suddenly in a moment while the printer is running, and it might be a cause of printer failure and glitch.

(2) Please don't use an electric tap with some outlet as much as possible because it might cause of fire and electric leakage. Also, please don't use a long cable between the computer and printer, or also between them with hub, because it might be easy to be influenced from noise which causes device failure and glitch.

4. Specification

Print method	Thermal transfer/Direct Printing
Feeding method	Roller style (Hopper) Roller feeding (Feeding part)
Deleting method	---
Printing dot density	12 dots/mm (approximately 300dpi)
Print speed	80 to 150mm/sec (Standard value)
Paper size	(W)40 to 100mm
	(L)50 to 300mm *Available for specially required size
	Wide type: (W)40 to 130mm (L)50 to 400mm
Paper thickness	0.2-0.8mm
Maximum printing area	(W) 100mm
	(L) 400mm
Hopper capacity	140mm
Font kind	Windows Font
Barcode	JAN8/13,ITF,UPC-E CODE39/93/128, EAN128, NW-7
	QR code, PDF417 etc
Interface	USB, Serial(RS232C), Parallel(Centronics), LAN(option)
Power supply	AC100V/240V common useful
Body size	W378mm×D335mm×H400mm
Weight	20kg

Operating Environment for Nice Label (printing software)

CPU: Intel or compatible x86 family processor

Memory: 2 GB or more RAM

Hard drive: 1 GB of available disk space

32-bit or 64-bit Windows operating systems: Windows 7, 8, 8.1, 10.

Microsoft .NET Framework Version 4.5.2

Recommended printer drivers: NiceLabel printer drivers V5.1 or higher

* Windows Server Core and Windows Nano Server are not supported

Connection of the Power Cable

The power cable is included in option box in carton case. If it was not found by any possibility, please contact us. The power cable included is single purpose for this printer. Please get the power code into the outlet all the way certainly when you use printer. And when you stopped using printer, turn off the power every time and pull out the power code, too.

Also, included power code is supported for each installation area in the world.

If it was mistaken or when you move the printer to another power code area, please contact us.

* When use ultrasonic cutter, follow the ruled way instructed before. Please install the amplifier

between the power source and the printer itself for the case out of Japan. If not use amplifier, the machine will break down inevitably.

Data transmission cable :

You can use USB, Parallel, RS-232C and LAN (option) cable for Venus series.

USB type

USB cable specification is “**USB2.0 Cable A and B**”. Insert A connector into the entry point of personal computer, and B connector into printer main body.

<Recommend: When using SuperRainbow.Net>

- Install print software and printer driver in your personal computer, you can use USB cable.
(You need HASP when sending a print data.)

<The other software including NiceLabel>

- Install FTDI driver when you send a print data through USB cable.

<http://www.ftdichip.com/Drivers/D2XX.htm>

There's in this site, please download “CDM v2.12.00 (*) WHQL Certified.exe”

(* This values mean software version.)

Parallel Type

Parallel cable specification is ”**D-sub25 pin (male) — D-sub25 pin (male)** ”.

Port name is “LPT1”.

RS-232C Type

RS-232C cable specification is ”(Reverse) ▪ **D-sub 9 pin (female) — D-sub9 pin (female)** ”.

Port name is “COM”.

LAN Type

On LAN cable connections, you have to use “**Straight cable**” to connect PC and the printer. You cannot use “Cross cable”. Please use “Straight cable” through to the “Hub” this is called a “**switching hub**”. But remember if it's the old type, it may not be put into use.

Please refer to the diagram below on how to connect.

Printer - Straight Cable - Switching Hub - Straight Cable - Personal Computer

Also, when you use LAN interface, you need to install LANTRONIX Device Driver in your PC.

Please install the file below and contact us when you set up the Lantronix.

http://ltxfaq.custhelp.com/app/answers/detail/a_id/644

5. Part Location & Part List

(5-1) Front view

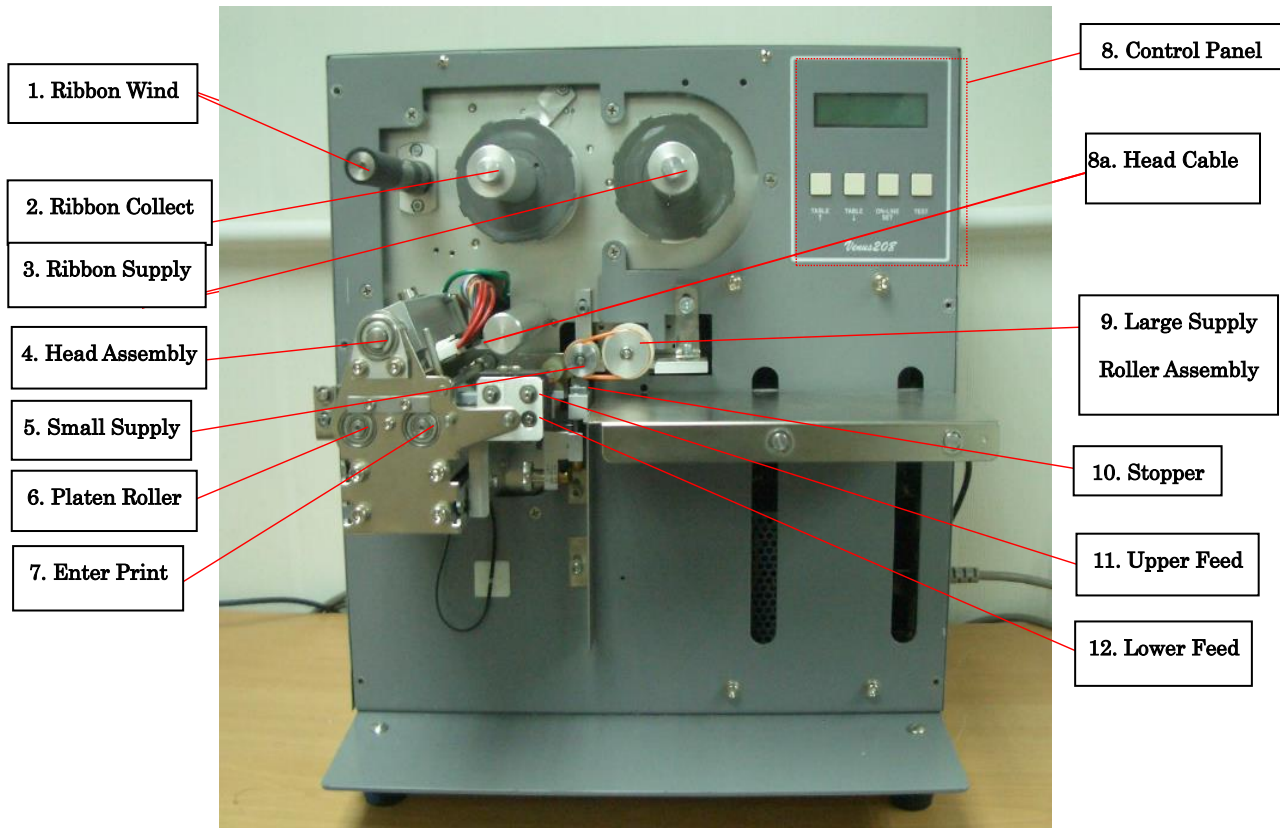

(5-2) Rear View without Cover

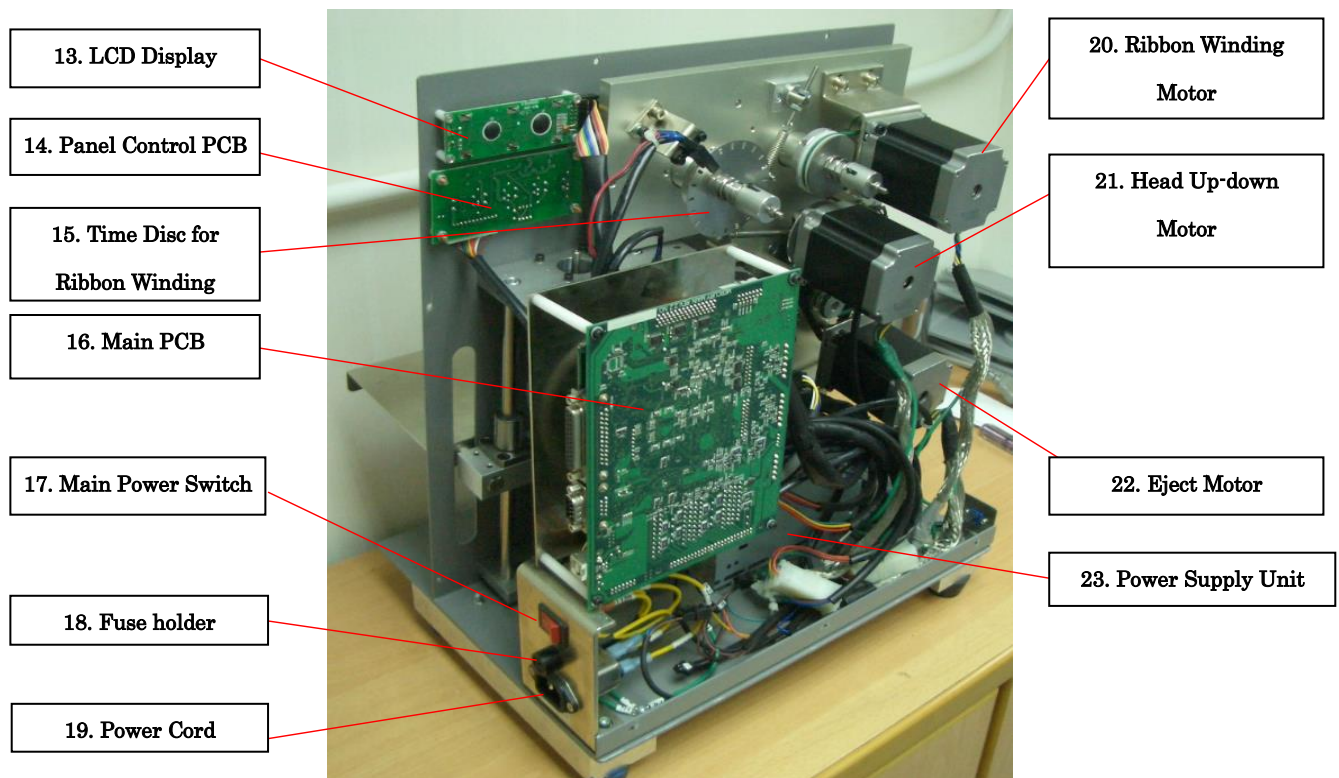

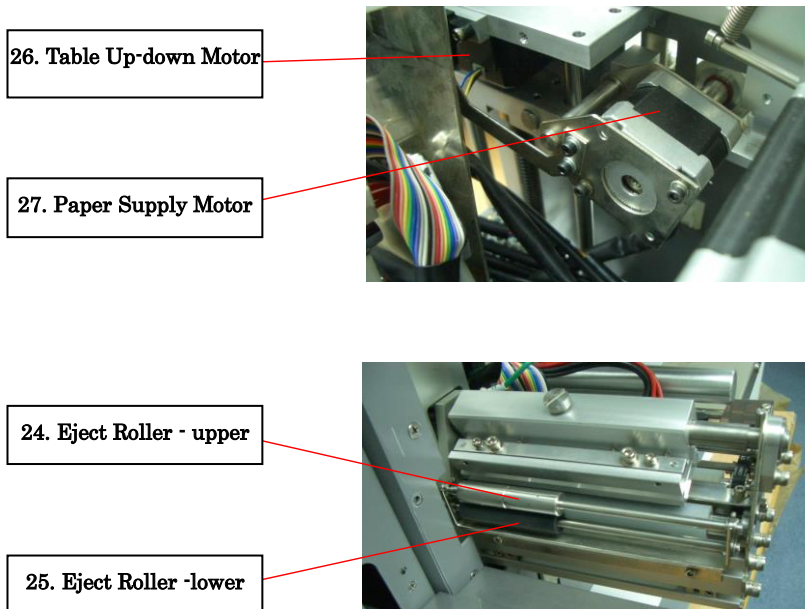

(5-3) Part List

Description	Location Code	Part Number
Ribbon Wind Rubber Roller	1	5201012
One Touch Guide	2,3	5111026
Thermal Head	4	5990007
Small Supply Pulley	5	5201025
orange belt for supply	5,9	5201023
Platen Roller	6	5201043
Enter Print Roller	7	5201043
LCD Display Board	8	5020005
Head Cable	8a	5201055
Panel Control Board	8	5020003
Supply Roller Rubber	9	5201070
Stopper	10	5201054
Feed Roller-upper	11	5201020
Feed Roller Gear (brass)	11,12	5201046
Feed Roller Gear (iron)	11,12	5201056
Feed Roller-lower	12	5201021
LCD Display Board	13	5020005
Panel Control Board	14	5020003
Main Board	16	5020002
Main Power Switch	17	5114030
Ribbon Wind Motor	20	5201075
Head Motor	21	5201008
Eject Motor	22	5201075
Eject Roller Upper (metal)	24	5201031
eject roller-lower	25	5201061
Table Up-down Motor	26	5201069
Paper Supply Motor	27	5201013

(5-4)Right Side View

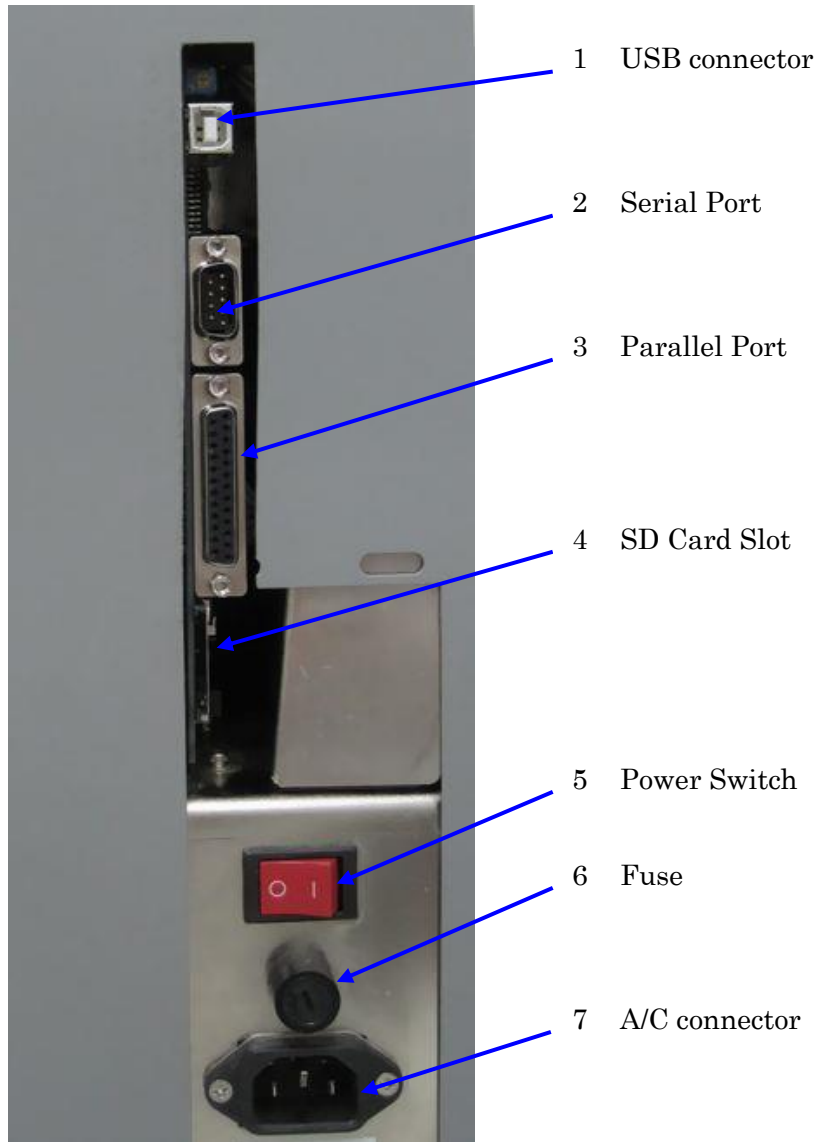

(5-5) Control Panel & Button Instruction

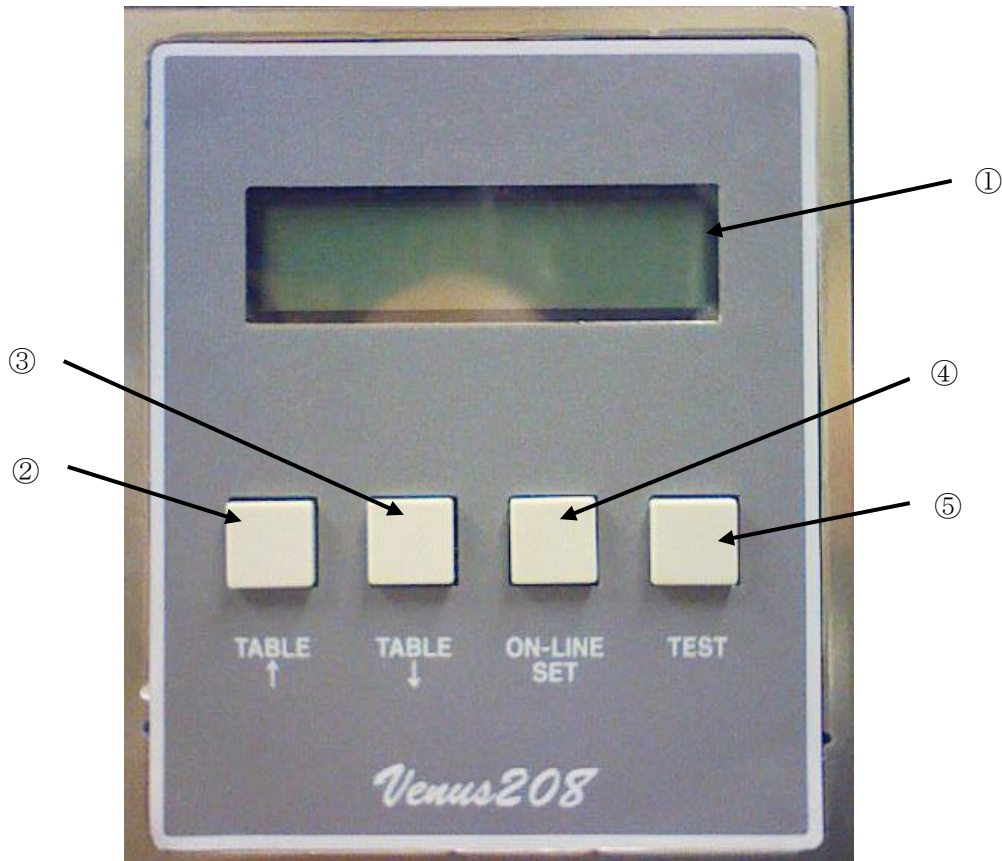

- ① Liquid crystal panel It displays error, condition, setting value and printing counter.
- ② TABLE ↑ Button < OFF-LINE >
 Pushed once stacker gets up and pushed once again it stops.
 < ON-LINE >
 It shows total amount of printing until then. (It disappears a few seconds later)
- ③ TABLE ↓ Button < OFF-LINE >
 Pushed once stacker gets down and pushed once again it stops.
 < ON-LINE >
 It displays total meter of run printer. (It disappears a few seconds later)
- ④ ON-LINE/SET You use this button when switching ON-LINE and OFF-LINE, and get into the internal setting mode.
- ⑤ TEST Button < OFF-LINE > pushing this button feeds one piece of tag without printing.
 < ON-LINE > pushing this button prints same data you send at last.

6. Setting of Ink Ribbon

When you begin to use newly and after finishing ink-ribbon installed already, please exchange it as following instruction. You can use at most 600meter roll of ink-ribbon for Venus specification.

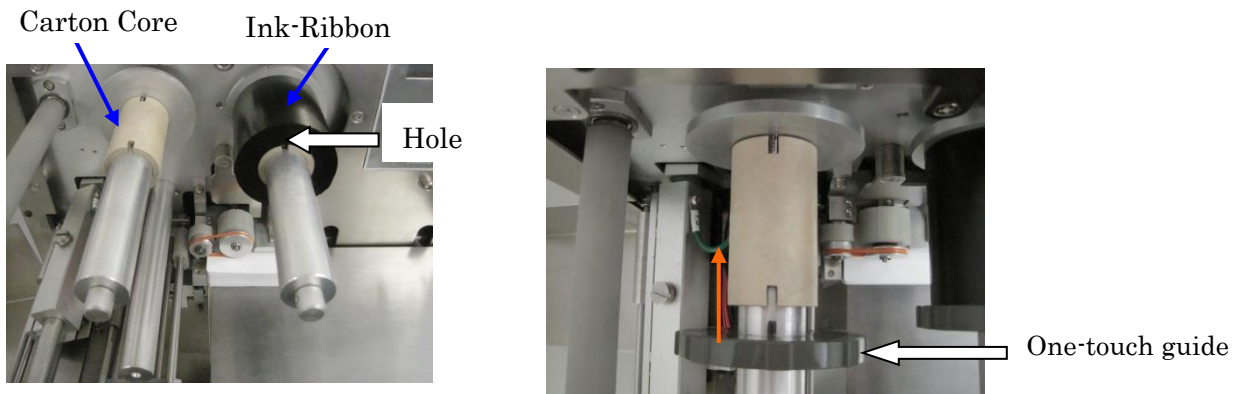
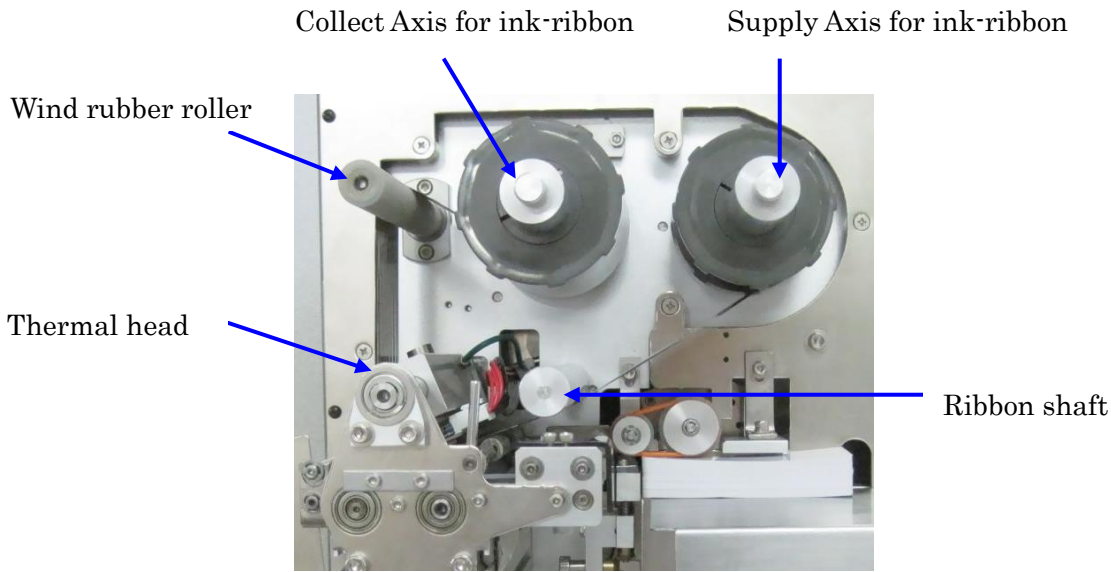

- 1) Place the roll of ink ribbon on the right mandrel (ink ribbon unwinding mandrel) and push the empty ribbon core on to the left mandrel (ink ribbon winding mandrel).
- 2) Place the roll of ink ribbon on the right mandrel (ink ribbon unwinding mandrel) and push the empty ribbon core on to the left mandrel (ink ribbon winding mandrel).
- 3) Place the roll of ink ribbon on the right mandrel (ink ribbon unwinding mandrel) and push the empty ribbon core on to the left mandrel (ink ribbon winding mandrel).
- 4) Attach the one-touch guide (outer guide disk) to both mandrels so a pin of the one-touch guide perfectly fit the notch of empty ribbon roll or ink ribbon, and rotate it clockwise to set.
- 5) See attached for your reference. It shows how to set ink ribbon.
- 6) Set the ink ribbon to the unwinding mandrel as follows:
 - Ink ribbon for involutely winding: set in an anticlockwise direction
 - Ink ribbon for revolute winding: set in a clockwise direction

- 7) Tape the end of ink ribbon onto the empty roll core (winding mandrel) and rotate it anticlockwise to set the ribbon tautness properly.

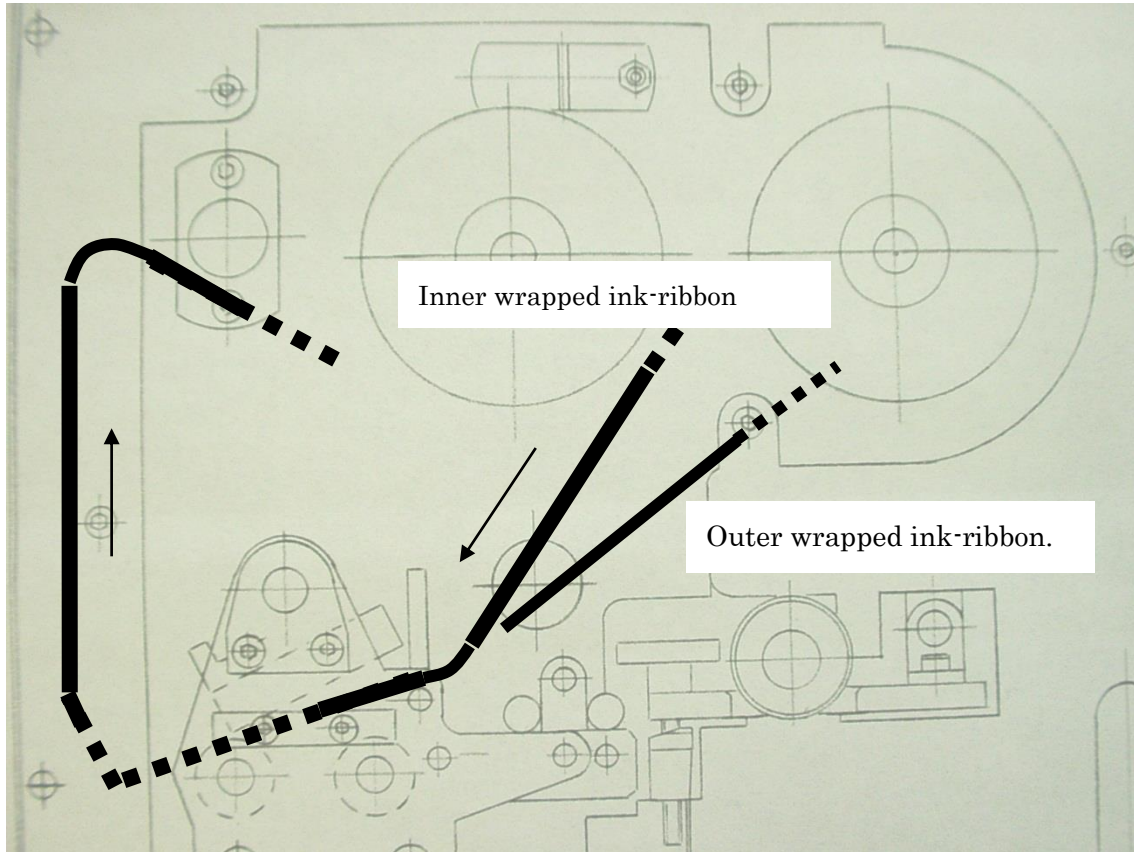

7. Setting of Tag

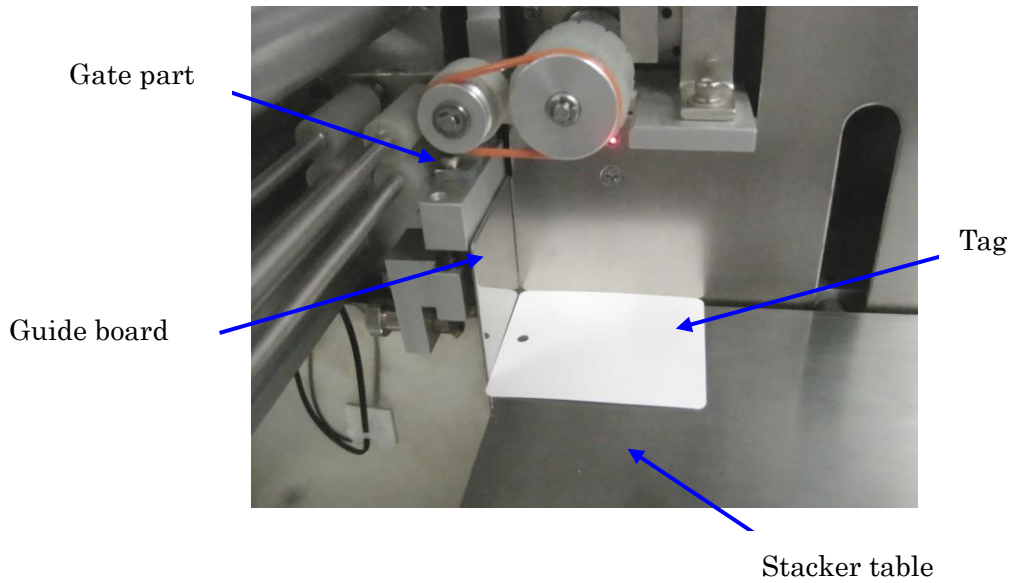

- 1) Turn the power on and push “ON-LINE” button once to change off-line. Next, push “TABLE ↓” button to turn down the stacker and again push it to stop it.
- 2) Please set tags fitting the corner of tag and vertical left and back board as set position.
- 3) Push “TABLE ↑” button once to turn up the stacker. (It stops automatically at limited height)
- 4) Set the feed support guide to fit the width of tag, and tighten the screw under the guide.

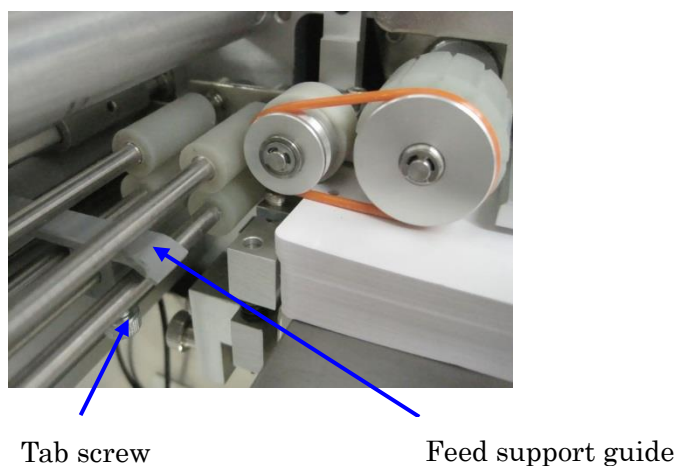

8. Setting of Stacker

(8-1) Simple Stacker

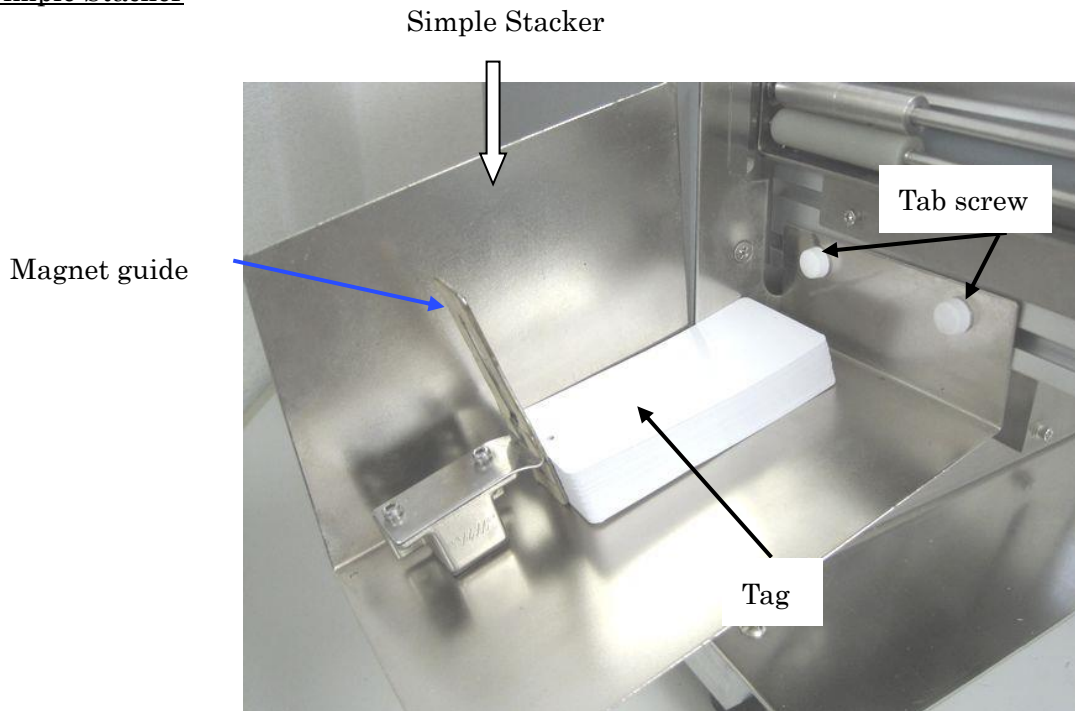

- 1) Set the stacker with two fix screws to the machine main body.
- 2) Put the stopper with magnet on the stacker at an appropriate position to accumulate printed tag.

(8-2) Auto Stacker

<Setting>

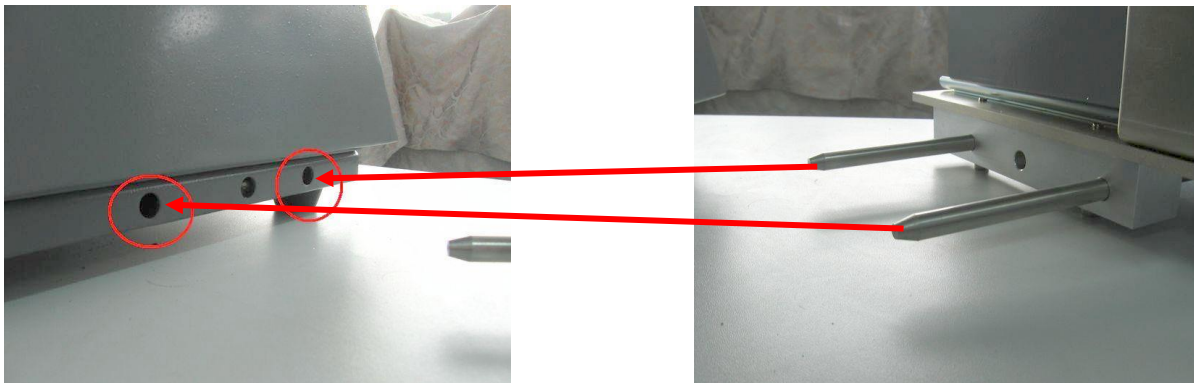

Adapt two arms at the bottom of stacker body to the hole of printer main body.



Connect the plug of the auto-stacker to the connector receiver at the left side of printer main body from front view, and tighten the cap of connector plug to the end.

(If by any chance the output and input connectors are different type, please contact us)

<Part Name>

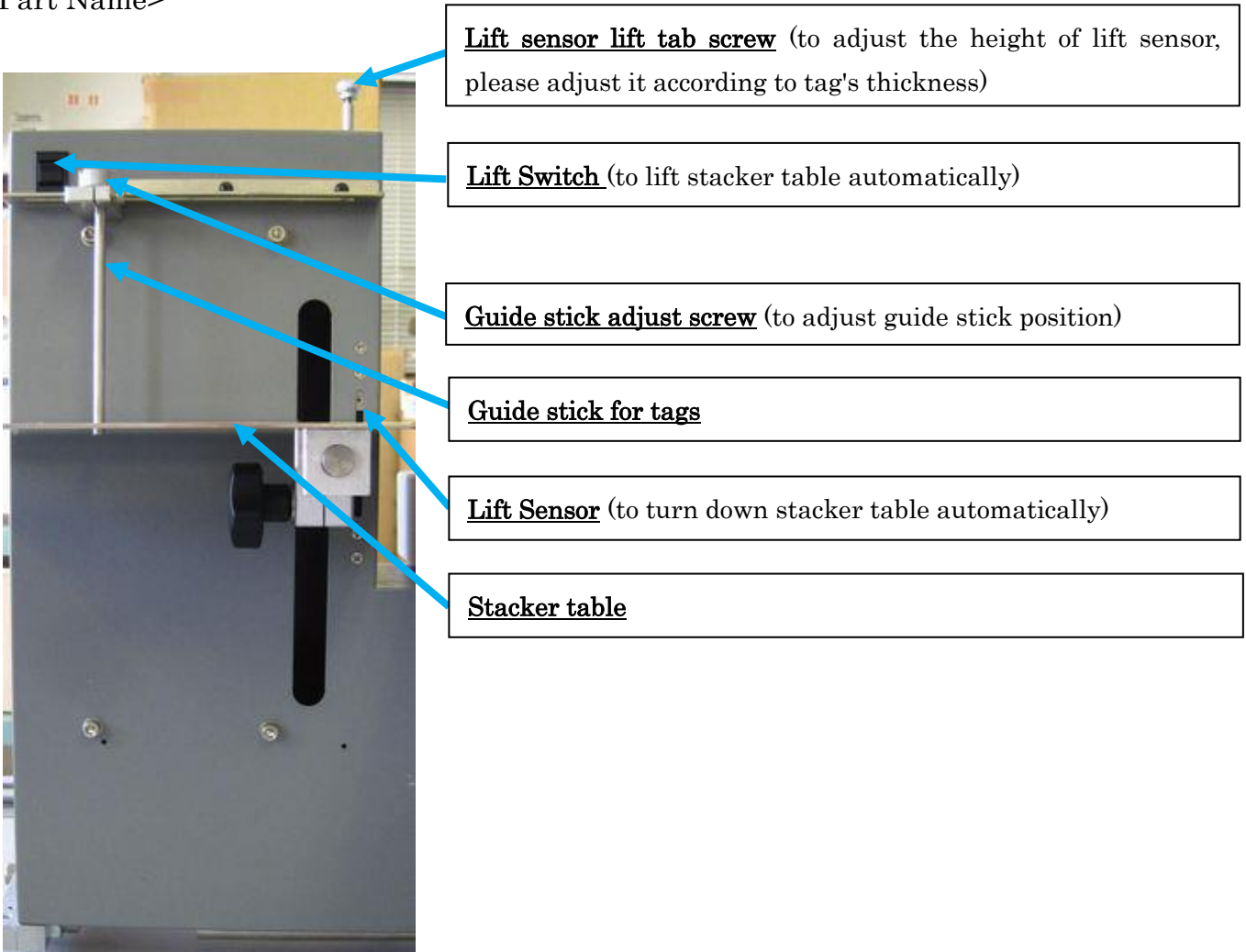

<Lift switch>



Lift switch has three steps.
Push upper of the switch : turn up the table.
Push bottom of the switch : turn down the table.

When you begin to use the printer, please make switch position middle surely, because if the switch would keep to be pushed upper, it will be cause of paper jam.

<Guide Stick>

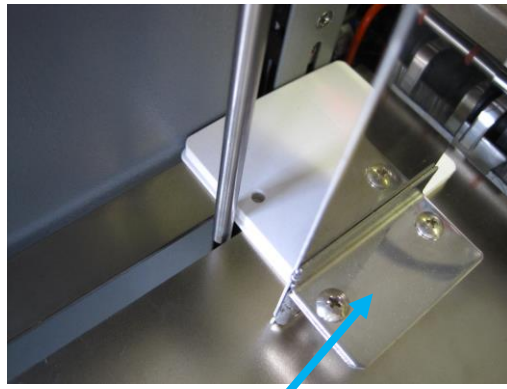

Magnet guide

Please set the guide stick in appropriate position by untightening the tab screw, and put magnet guide at the left side of the tag.

When the stacker table turn down to the bottom, printer stop running and LCD display of the printer main body's control panel shows "Stacker Full". Then please turn it up with lift switch.

9. Adjustment of Ink-Ribbon Tension

You will need to adjust ribbon tension sometimes when some of tiny black lines appear at random or vertically on the tag.

Finger screw for winding ribbon

Finger screw for supplying ribbon

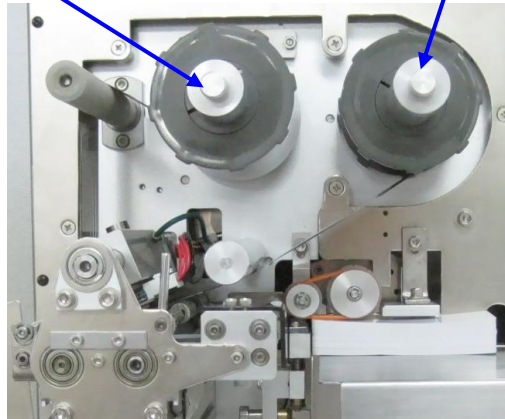

1) Adjustment of winding Ink-Ribbon

Turning on finger screw clockwise direction increases power to wind ink-ribbon, and anti-clockwise direction decreases it.

2) Adjustment of Braking Ink-Ribbon

Turning on finger screw clockwise direction increases power to brake ink-ribbon, and anti-clockwise direction decreases it.

10. Adjustment of Gate (Gap adjustment)

This part prevents from duplex feeding of tag. When you change to use another tag is different thickness, please adjust the gap of the gate part.

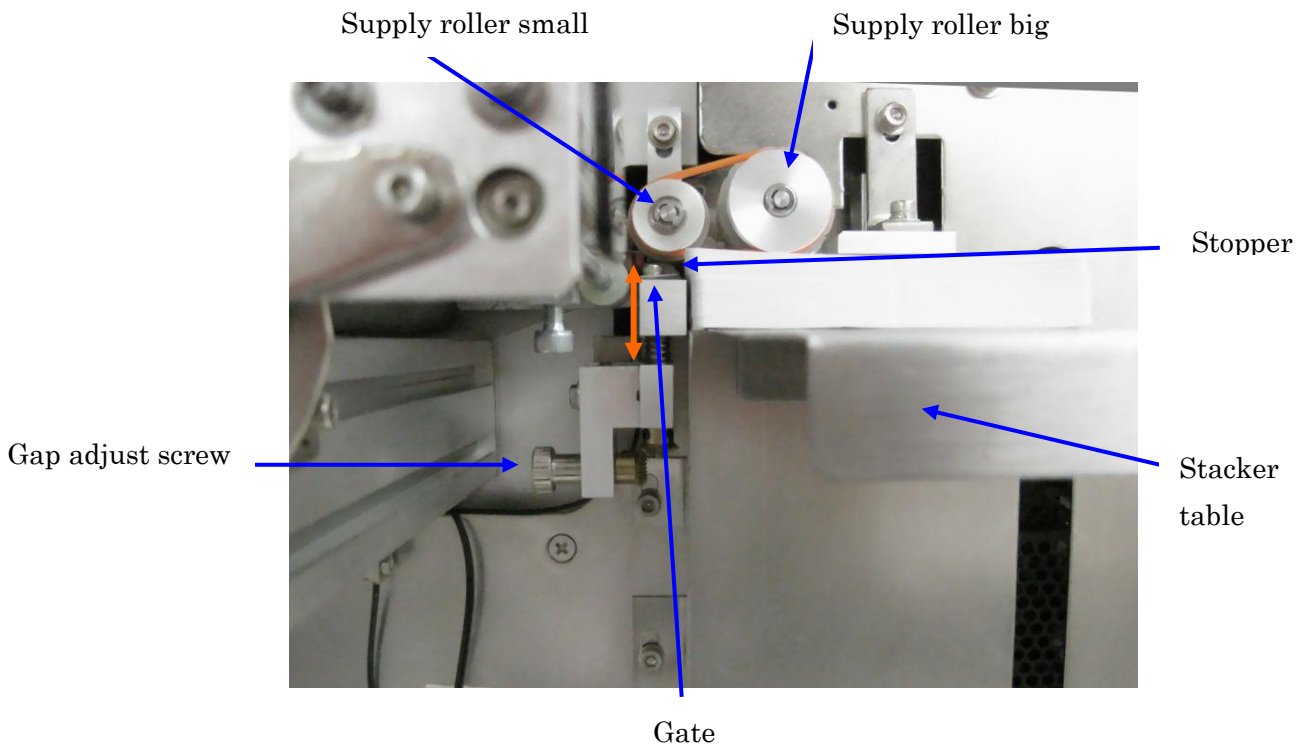

- 1) Adjust the gate to be fed one piece of tag smoothly between the supply roller small and stopper with gap adjust screw.
- 2) You can broaden out the gat by turning round the gap adjust screw clockwise direction. In opposition, narrow down it by turning round the screw anticlockwise direction.

11. Adjustment of Print-Head Pressure (A)

Head pressure adjustment block

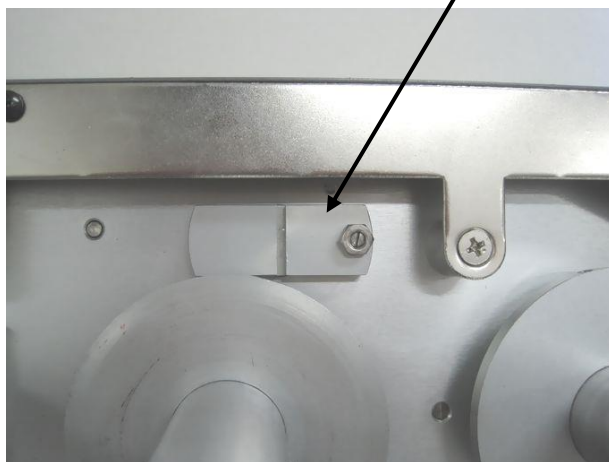

Adjust head pressure by 3 levels.



Standard (5.0kg)

middle (5.5kg)

strong (6.0kg)

11. Adjustment of Print-Head Pressure (B)

Power off the machine and unplug the power cord first before the following steps.

1. Open the machine back cover by loosening 7 screws at front side and 3 screws at the back (or with 4 screws at right and left side).

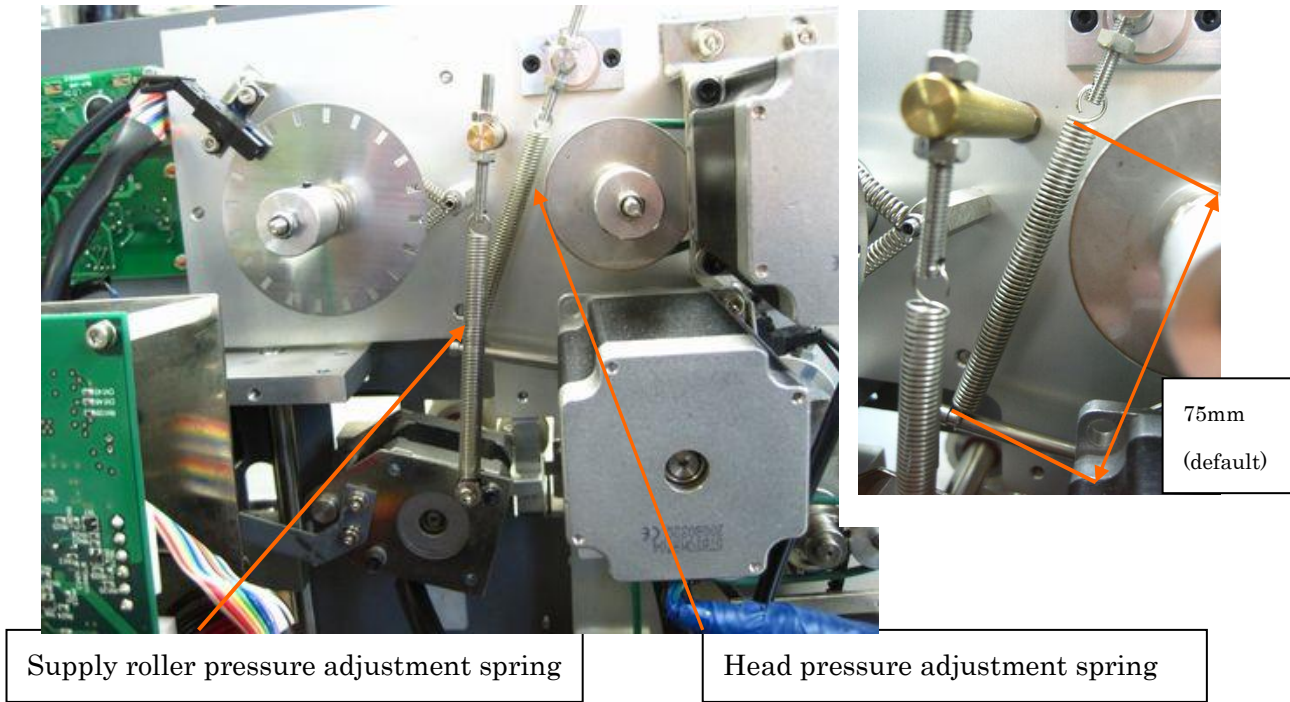

2. To strengthen the head pressure, loosen the lock nut and tighten the tune nut in order to increase the spring length with apply more pressure on spring.

3. To weaken the head pressure, loosen the tune nut in order to reduce the spring length which release the pressure on spring. Tighten the lock nut after the tuning is done.

12. Adjustment of Head Position

Power off the machine and unplug the power cord first before the following steps.

1. This adjustment is to be carried out when poor print out sharpness and it is not related to the head pressure, head alignment, ink ribbon tension, tag material or printing speed etc. Anyway, just consider this as the last way to be adjusted, it need not to be done quite often except the thickness or material of tag has a big change.
2. This adjustment is to shift the position of the Head Adjust Level which directly hold the Thermal Head, that means the thermal head also be move accordingly. Please keep in mind that the Lever Gap should be kept in parallel after the adjustment.

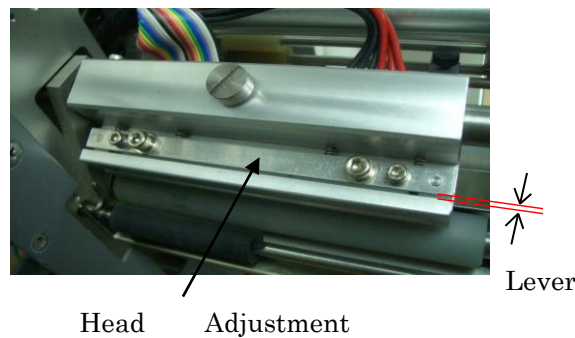

3. Adjustment method :

- 3-1. Loose 4 fixing screws (2xM3 & 2xM4) a little just let Head Adjust Lever can move.
- 3-2. Using a 1.5mm Allen Key to adjust 2 set screws in order to shift the Head Adjustment Lever to shift up or down
- 3-3. For most of the cases, the lowest position of the Lever (minimum gap dimension) should give the sharpest result, of course, it depends on size and material of tags, and do not have a rule on how should the best, just compare by different trial and get the best set up.
- 3-4. Tighten up the 4 fixing screws after the adjustment done, and beware the Lever gap should be kept in parallel.

Fixing Screws (M3 & M4)

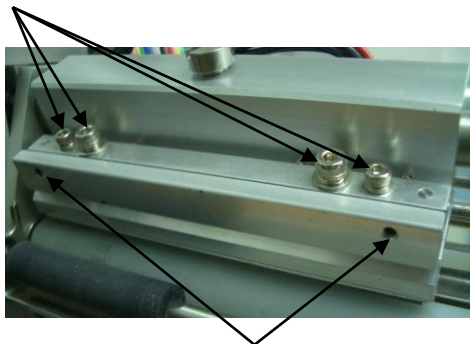

Adjust Set Screws

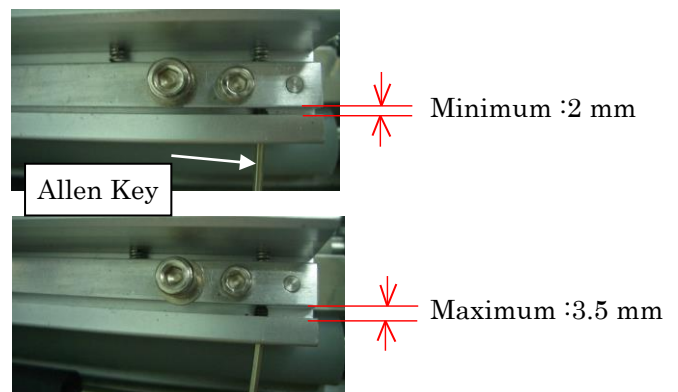

13. Cleaning Part

Please clean some parts below regularly with cotton swabbed cleaner liquid.

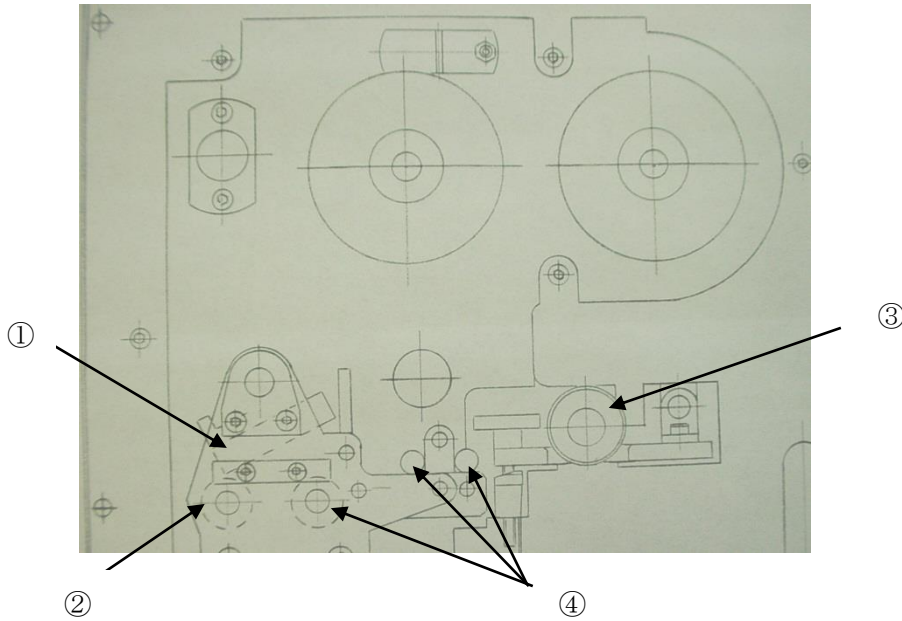

① Thermal Head (Heat element under and edge of thermal head)

② Platen Roller

③ Supply Roller

④ Feed Roller

14. How to Clean Thermal Head & Platen Roller

Thermal head is consumable parts and getting dirty with ribbon-dust melted little by little while the machine prints data on tag. So it should be cleaned diligently and regularly with cotton transfused alcohol to keep thermal head durability longer.

So, whenever you clean thermal head, please observe following things.

Equipment

- Flat head screw driver (edge length over 5mm)
- Cleaner liquid (*)
- Napless material like cotton (**)

Our recommendation frequency :

Once for exchanging an ink-ribbon. Cleaning thermal head diligently prevents from failure of printing and thermal head itself.

*

Recommended Cleaner liquid for cleaning print head :

"Ethanol (Ethyl Alcohol) " over 95 % . High-volatile and inoffensive to human body. Please never use "Methanol (Methyl Alcohol)" because of highly-flammable and offensive to human health. Also to clean with equal or less than 86% alcohol liquid might give dangerous for the heat element of print head. If you use printer soon after cleaning as the heat element keeps water even a little (in the case of using equal or less than 86% cleaner liquid), it breaks possibly the heat element immediately, because when heat element keeps to hold heat in a water that prevents emission of heat, it will offense heat element itself. So please use cleaner liquid of having over 87% alcohol at least, or after cleaning wipe there definitely with dried cotton.

**

Recommended cleaning material :

Less fuzzy fabric material like cotton and gauze.

Tissues (Kleenex) and surgical cotton have much fuzzy and if you use them for cleaning, fabric tiny thread of the material may be left on the surface of thermal head heat element which might cause of head break, suppose you restart to print as it is. So if you have to use tissues and surgical cotton, please wipe cleaning liquid and tiny fabric thread there with dried material at last.

Power off the machine and unplug the power cord first before the following steps.

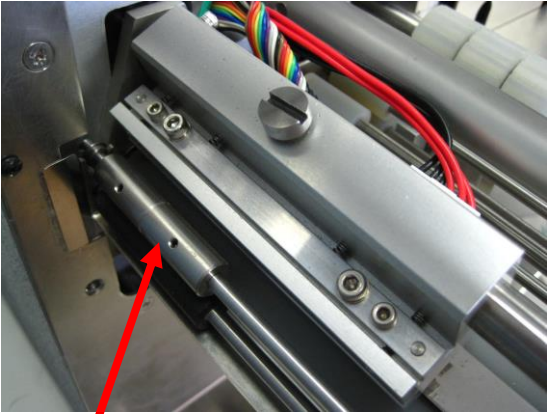

1. Please get out the eject roller upper.

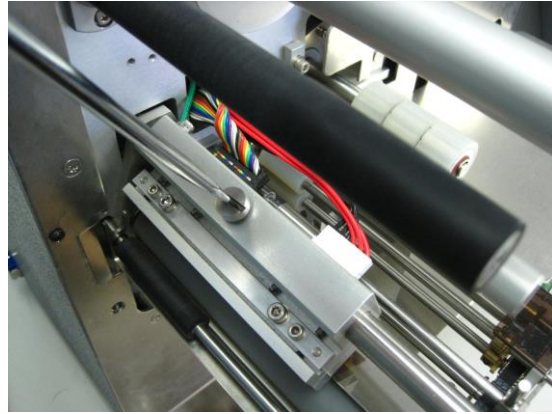

2. Unscrew the fixing screw on head holder.

3. Got out fixing screw, not bring it up soon but draw the head-holder to before side.

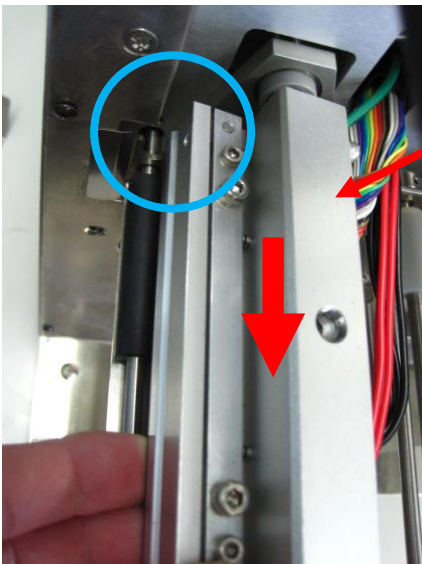

Bringing up head holder without drawing it could injure the head heat element and cause thermal head failure. So be sure to draw it.

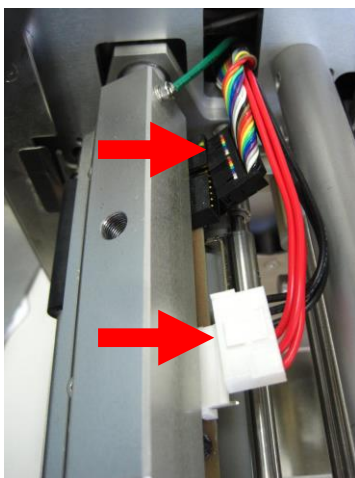

4. Unplug 2 wire connectors from thermal head.

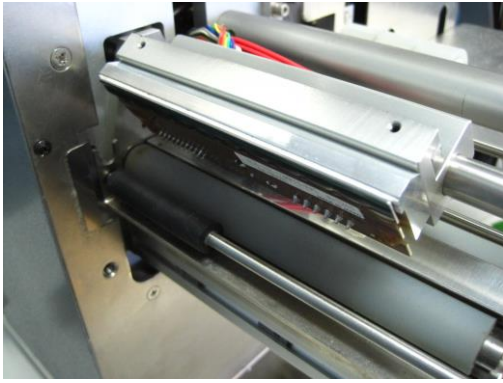

5. You can bring head holder up by hand, and clean the edge of thermal head with cotton swabbed cleaner liquid or alcohol for cleaning.

(When you clean the thermal head, scrub it strongly by your hand. Because sometimes ribbon-dust is very sticky so that you might not clean it only by wiping there lightly.)

15. How to Replace Thermal Head

Power off the machine and unplug the power cord first before the following steps.

A) Unscrew the fixing screw on head holder

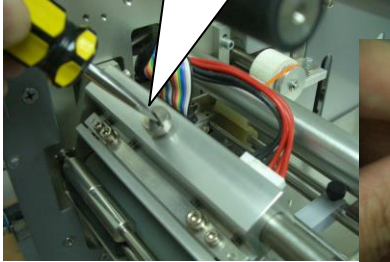

B) The fixing screw is in V-shape



C) Unplug 2 wire connectors from thermal head

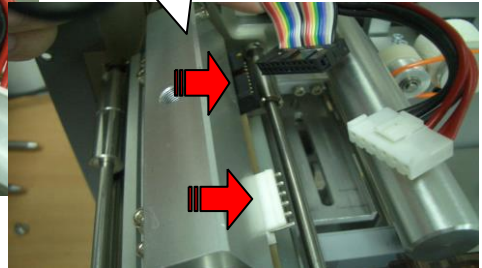

When lifting the head part, please pull it to front from back side, because it might injure head heat element.

D) Use a M3 Allen key to screw out the 2 pointed screws

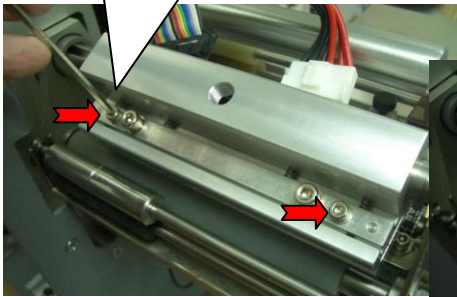

Screw holes left

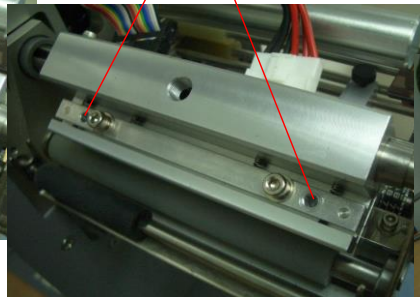

E) Take off thermal head carefully from holder

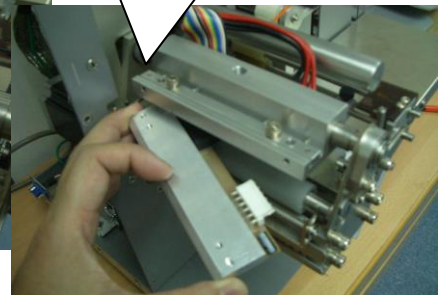

F) Record down the resistance value of the new thermal head, for this example, it is 1210 ohm

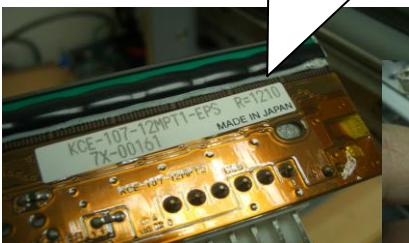

G) Put the new thermal head carefully back to holder and tighten up the 2 mounting screws

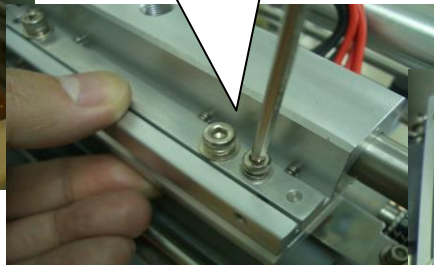

H) Plug in the 2 wire connectors to thermal head

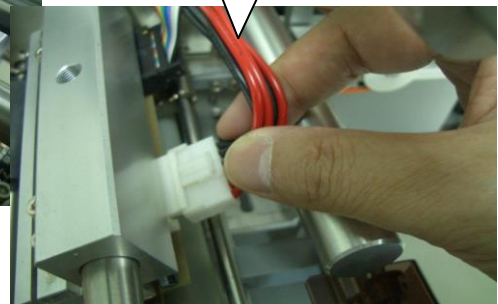

I) When put the fixing screw on, the head holder must be push to machine side thoroughly

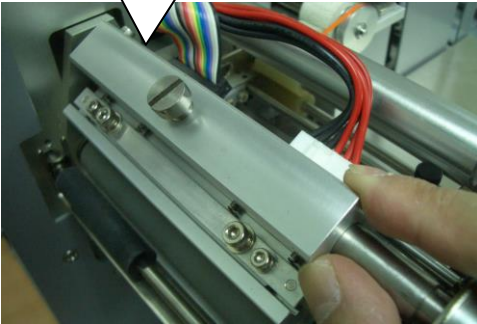

J) After install the new thermal head, the correct resistor range in internal manual must be selected

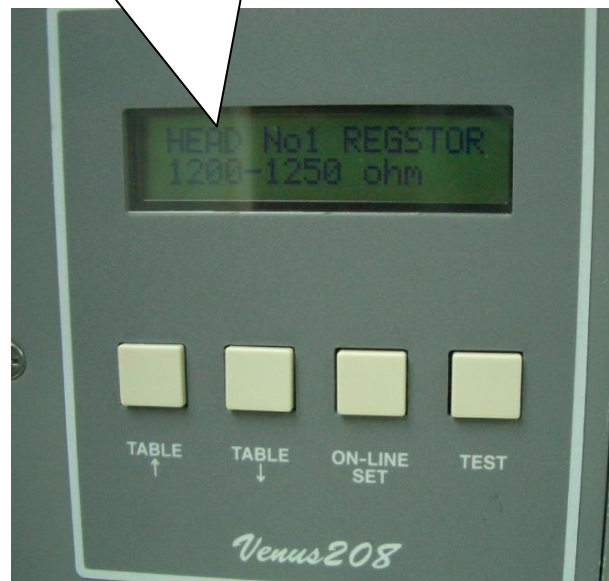

Procedure for select resistance value range:

1. Press and hold the "SET" button on panel and power on the main switch, do not release the SET button until the "Head Register " manual shown on display.
2. Press "↑" or "↓" button to change the resistance range (50 ohm per step) according to thermal head resistance you just installed.
3. After the correct resistance set, it will be updated immediately, just power off the machine to exit the manual.
4. Power on the machine again and continue the operation with new thermal head.

16. How to Replace Platen Roller

1. Please turn off the power.

2. Loosen two screws with hex. wrench and remove the small board guarding the bearing

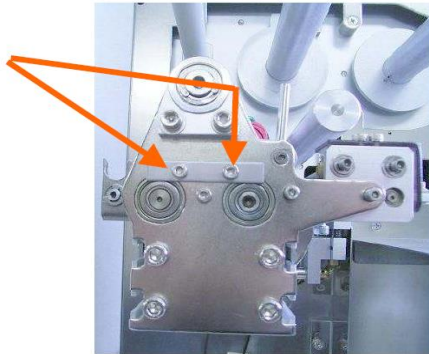

3. Loosen screws on reverse side cover and open the cover.

Feed Motor

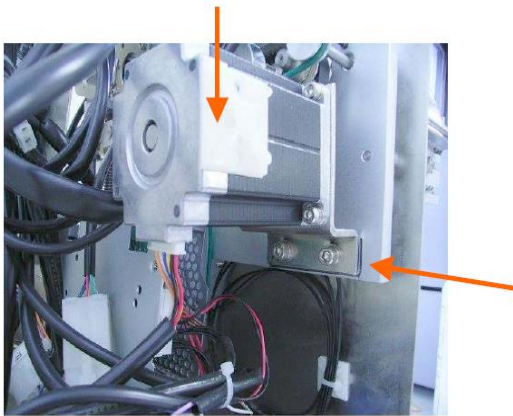

Please sign the original position with pen just in the before loosening feed motor attachment board screws.

4. Loosen screws of feed motor attachment board

5. Loosen the black belt tension and set screw of platen roller pulley to remove platen roller.

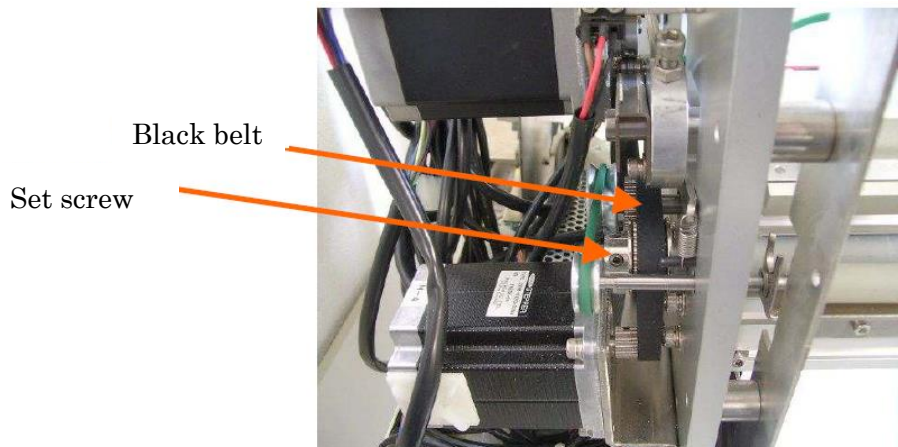

6. Replace platen roller to new one and please install the other parts in reverse procedure.

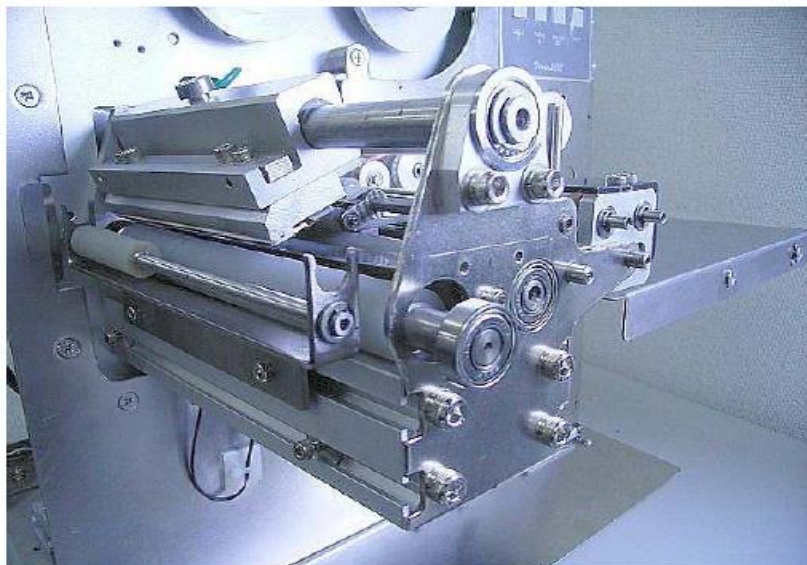

7. Please be careful of installing position of platen roller pulley not to touch with eject roller pulley.

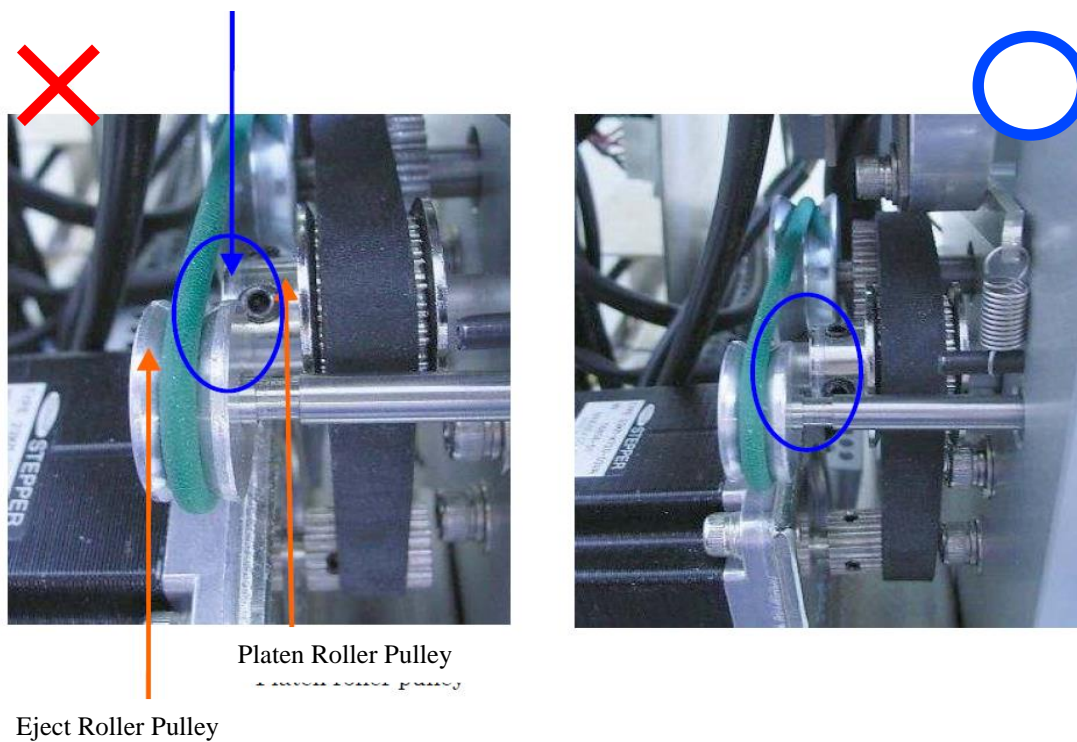

17. How to Replace Stopper

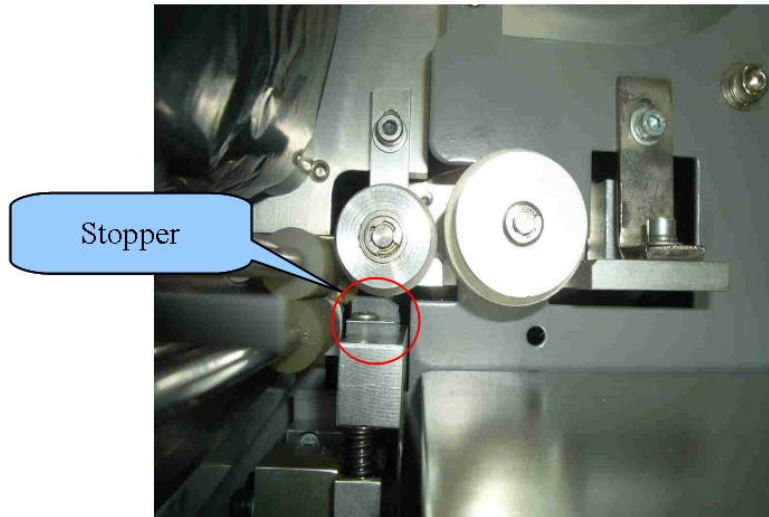

Take off orange driving belt.



1. Unscrew 2 pieces M2.5 hex screws and take off the Small Paper Feed Roller Assembly.



2. Take off 2 cross head screws on Stopper, and disassemble the old Stopper.

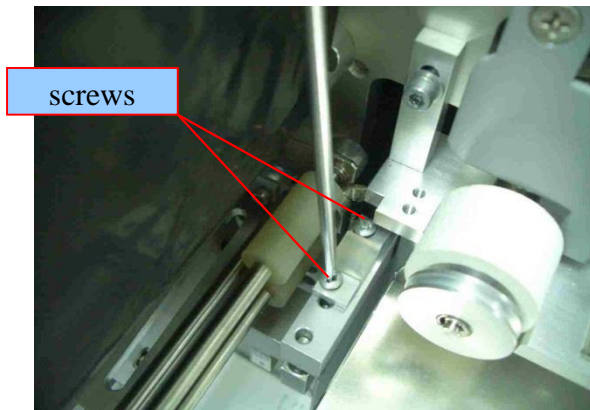

3. Put the new Stopper on the location in reverse order of the above illustrations

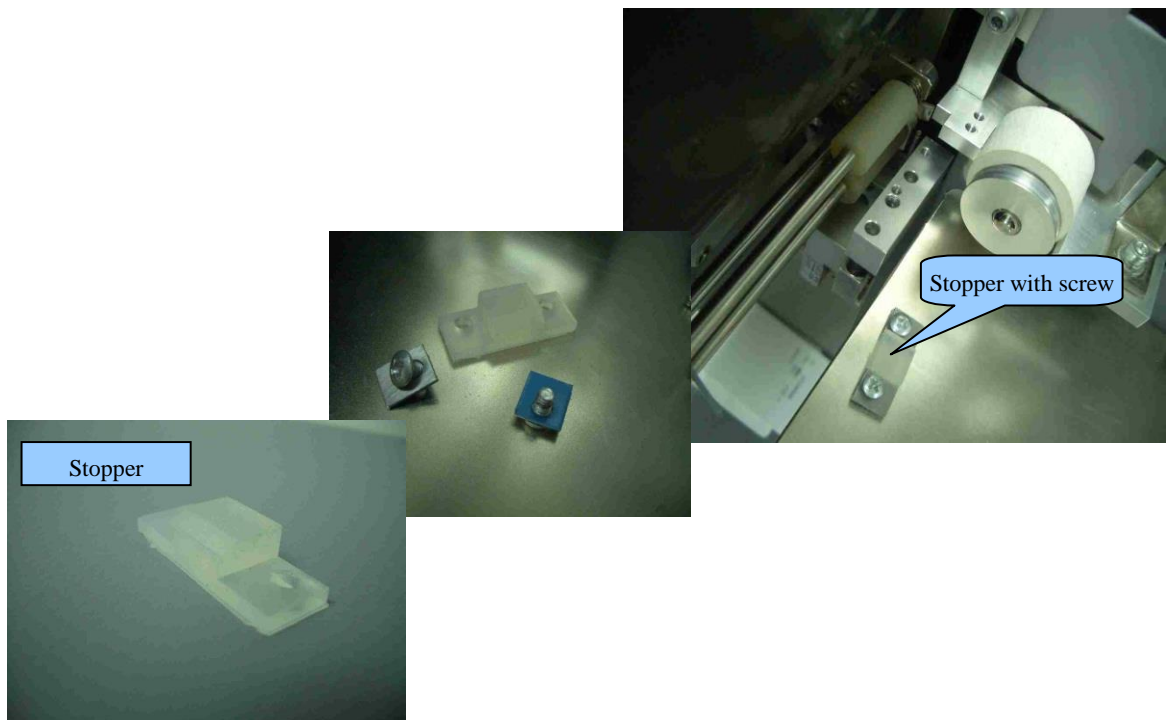

18. Error List

- | | |
|---------------------|---|
| 1) Paper End | No paper. Add papers and push "ON-LINE" key |
| 2) Ribbon End | No ink ribbon. Ink ribbon was cut on the way.
Replace ink ribbon to push "ON-LINE" key. |
| 3) Paper Jam | Paper jams on the way.
Remove paper to push "ON-LINE" key. |
| 4) Cover Open | Cover is opening.
Close cover to push "ON-LINE" key. |
| 5) Stacker Full | Stacker is at the bottom.
Remove stacked papers to push "ON-LINE" key. |
| 6) Abnormal Head | Detect abnormal state (Timing off) of head action
for up and down.
Push "ON-LINE" key (Adjust mechanically at
occurring frequently). |
| 7) Data Error | Detect abnormal data. Check printing data. |
| 8) No Printing Data | No printing data.
Transfer printing data to print again. |

19. Panel Setting (v1.90)

Venus208 Panel Setting

Program V1.90~

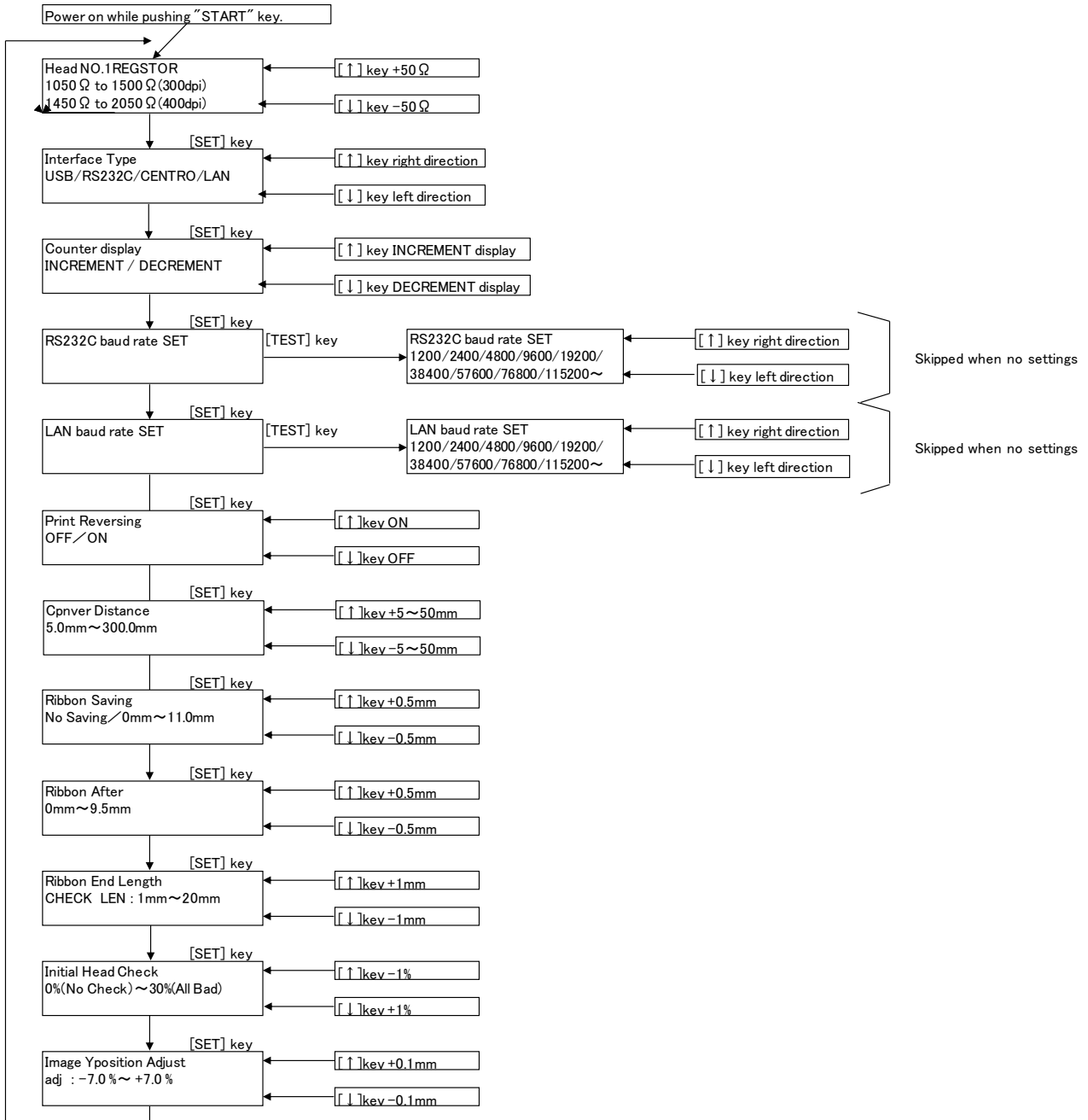

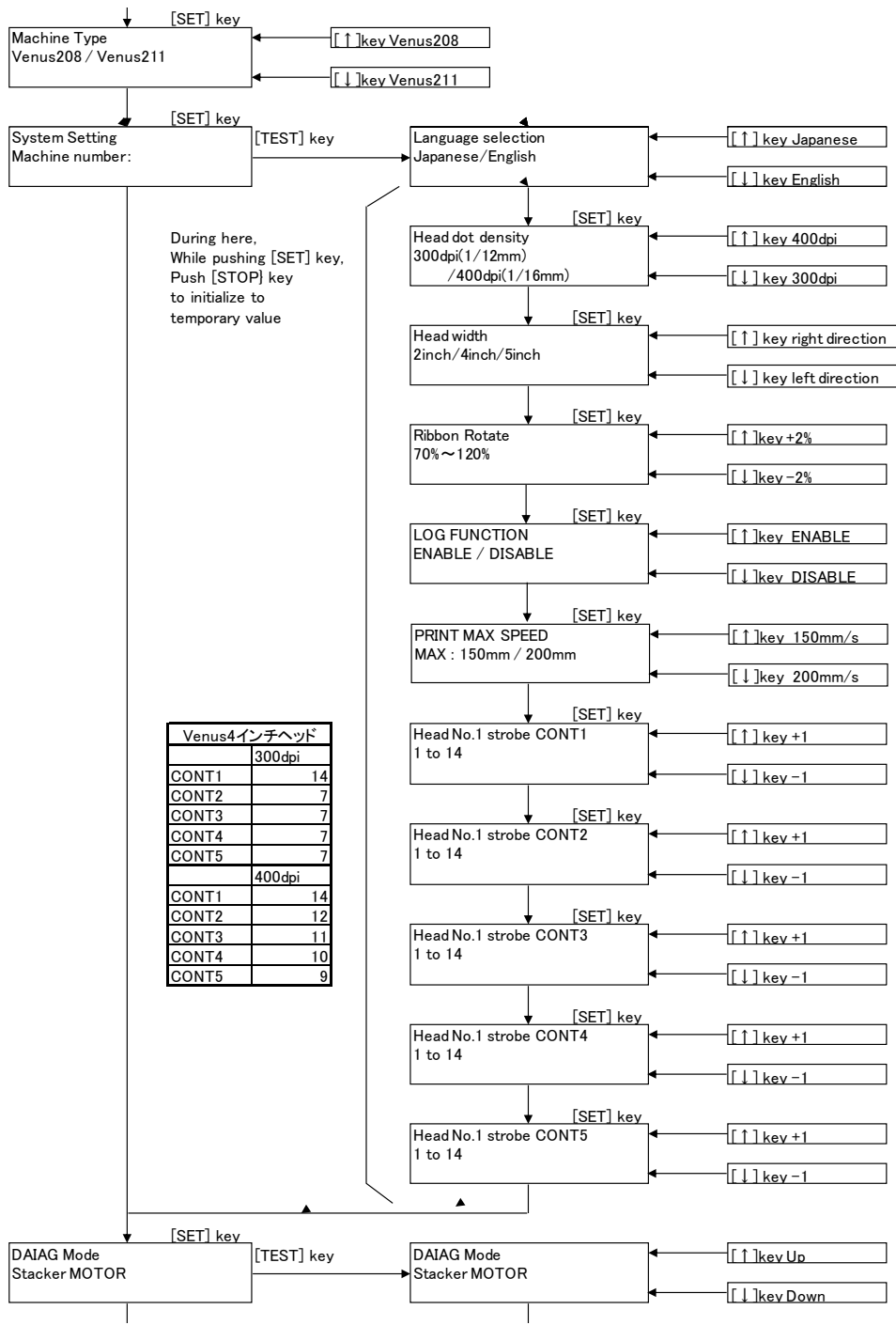

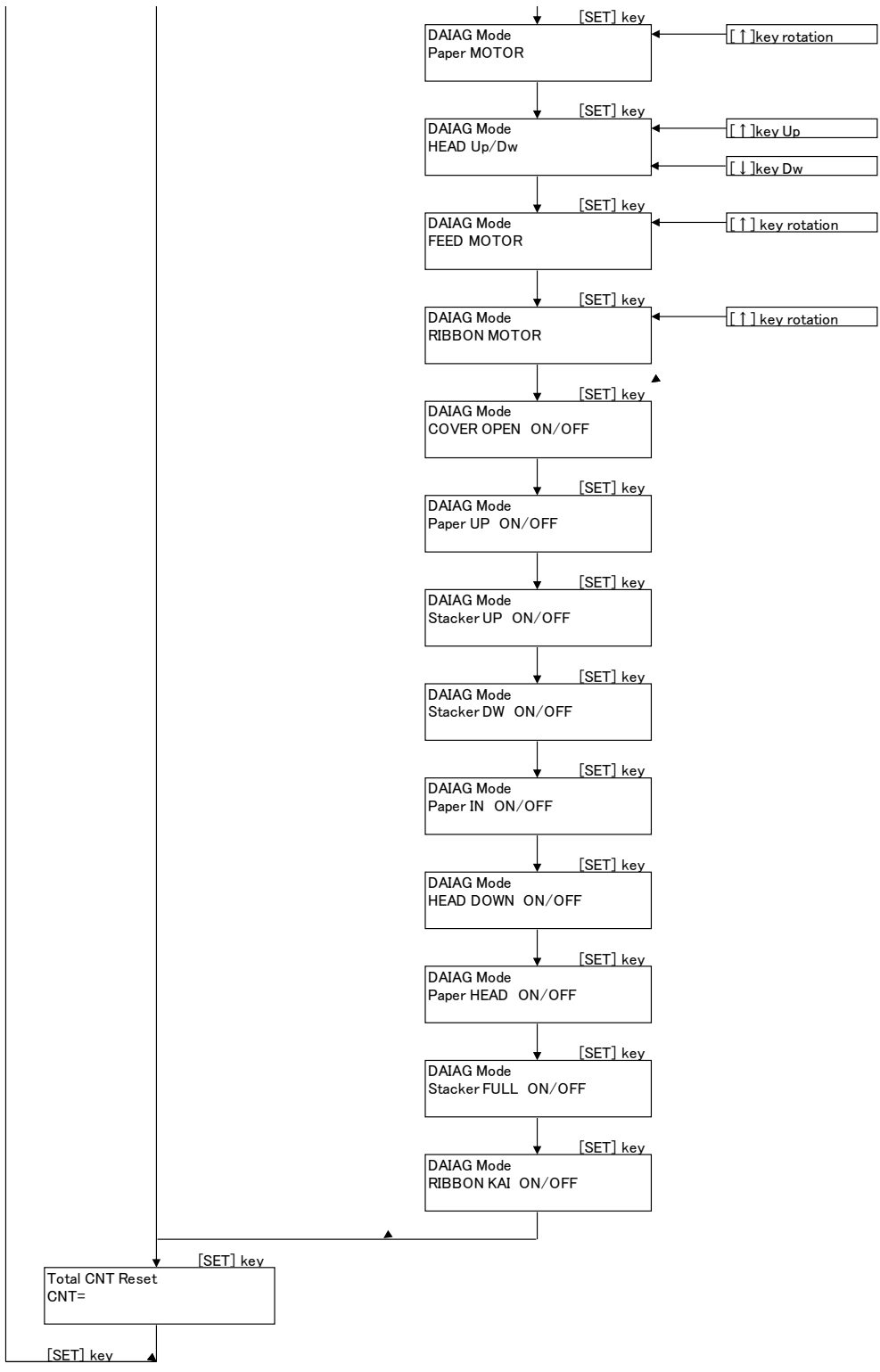

20. Internal Setting Instruction (v1.90)

(☉=default setting)

Head REGISTOR (Resistance)

1050 Ω ~ 1500 Ω (300dpi) (↑ +50 Ω ↓ -50 Ω)

1450 Ω ~ 2050 Ω (400dpi)

☉factory default setting

Be sure to set “Head Resistance” again correctly when you replaced thermal head.

(If you forgot to set head resistance correctly after replacing it, head break may become very early)

Interface Type

I/F : USB / RS232C / CENTRO / LAN

☉USB

Counter display

Increment / decrease

You can select counter type of increment or decrease when printing.

☉Increment

RS232C baud rate SET

(Skipped when no settings)

1200 / 2400 / 4800 / 9600 / 19200 /

38400 / 57600 / 76800 / 115200~

☉factory default setting

LAN baud rate SET

(Skipped when no settings)

1200/2400/4800/9600/19200/

38400/57600/76800/115200~

☉factory default setting

Print Reversing

OFF / ON

☉OFF

This is function that you can change the print direction in reverse (180 degree).

Conveyer Distance

5.0mm ~ 300.0mm (↑ +5 ~ 50mm ↓ -5 ~ 50mm)

☉60mm

This is amount of rotating of supply roller big. According to the tag you use, please change this value.

Otherwise it may cause of paper end error and paper jam error.

Ribbon Saving

No Saving / 0.0mm ~ 1.0mm (↑ +0.1mm ↓ -0.1mm)

◎ No Saving

This is function you can save the amount of winding ribbon every one piece of tag.

When you set “No Saving”, head doesn’t get up during printing. When you set “0.0mm”, head gets up after printing every one piece of tag.

With tag’s material and surface treated, ribbon saving might cause of print graze.

Ribbon After

0mm ~ 9.5mm (↑ +0.5mm ↓ -0.5mm)

◎ 0mm

This is timing of getting up thermal head after printing one piece of tag.

If you found a black light line or print graze a little at the bottom on the tag by the tag’s material and surface treated, please change this value.

Ribbon End Len (ribbon end detection)

2mm ~ 20mm (↑ +1mm ↓ -1mm)

◎ 16

This is sensor degree of accuracy to detect ribbon-end.

When the tag is long but the print data is one small area of tag, or the print data has only one or two rows, it is not enough to wind ribbon to detect at sensor. So it may cause of ribbon end error, even though the ribbon does not finished at all. In such case, please change this value.

Initial Head Check

0%(No Check) ~ 30%(All Bad) (↑ +1% ↓ -1%)

◎ 13%

This is function that you can check head break sensitivity.

Please be sure to set between 10% or 13% definitely when you print barcode.

Image Ypos Adjust

adj: -7.0 ~ +7.0%

◎ 0.0%

You can adjust printing data position vertically (in Y position). Up to the weariness of platen roller and thickness of tag you use, it may change accordingly a little different with image on PC software and actual printing position.

Machine Type

Venus208 / Venus211

◎ factory default setting

System Setting

Machine number :

First numbers are serial number and the latter numbers are the product date of this printer's main board.

Language selection

Japanese / English

factory default setting

Head dot density

300dpi(1/12mm) / 400dpi(1/16mm)

300dpi

Head width

2inch / 4inch / 5inch

4inch

Ribbon Rotate

70%~120% (↑ +2% ↓ -2%)

100%

This is function you can change the power (amount) of winding ribbon. If the ribbon is easy to be cut, change this value into low. Or if print often came to graze, please set it to high.

LOG Function

DISABALE / ENABLE

DISABALE

You can save the printer control and printing history into SD card.

Usually this function is for RFID print.

PRINT MAX SPEED

150mm / 200mm/s

200mm/s type is special order function, usually this function is for RFID print.

Head No.1 strobe CONT1

1~14

14

Head No.1 strobe CONT2

1~14

7

Head No.1 strobe CONT3

1~14

◎7

Head No.1 strobe CONT4

1~14

◎7

Head No.1 strobe CONT5

1~14

◎7

Head strobe rule is firstly No.1 strobe must be set the highest value around 14-12. And please set the value decreasing gradually like “14,10,9,8,7” this is okay, for example.

However you must not set like “14,7,7,7,8”, this will cause to breakdown of thermal head and main board probably sooner or later. You must set the lowest value at CONT5.

DAIAG Mode <Driving check mode> (with TEST button into this mode)

Stacker MOTOR ↑ UP ↓ DOWN

You can check the driving of stacker (table) motor.

Paper MOTOR ↑ Rotation

You can check the driving of supply (roller) motor.

HEAD Up/Dw ↑ UP ↓ DOWN

You can check the driving of head up/down motor.

FEED MOTOR ↑ Rotation

You can check the driving of feed motor.

RIBBON MOTOR ↑ Rotation

You can check the driving of ribbon wind motor.

COVER OPEN ON/OFF

You can check the behavior of cover sensor. (by trying to cover the sensor)

Paper UP ON/OFF

You can check the behavior of tag set part sensor.

(it may not work, up to the printer's lot number)

Stacker UP ON/OFF

You can check the behavior of the auto-stacker upper limited sensor.

Paper IN ON/OFF

You can check the behavior of paper end sensor.

(by trying to cover the sensor, you'll find to switch ON/OFF on machine's display)

HEAD DOWN ON/OFF

You can check the behavior of head up/down sensor.

(which is at nearby head up/down motor)

Paper HEAD ON/OFF

You can check the behavior of paper jam sensor (under the head part).

Stacker FULL ON/OFF

You can check the behavior of stacker full sensor of auto-stacker.

RIBBON KAI ON/OFF

You can check the behavior of ribbon end sensor.

CS0 : ff00

You can check the behavior of ↑ button and ↓ button.

Total CNT Reset

CNT= this is total counter.

21. How to Clear Print Data without turning off power (from v3.89)

Please follow the below step when you want to clear the data you already sent to the printer without turning off power source.

Resent condition

“OFF LINE” + “Push STOP key for over 4 seconds”

22. How to Update Printer Firmware

Procedure

1. Prepare “SD-card” of SDHC (SD High Capacity) standards and put the firmware “MERCURY.BIN” for version update in your SD-card on PC.



※ Active certification of SD-card on this printer is until 2GB. We haven't guaranteed over 2GB SD-card. Please don't rewrite firmware with over 4GB SD-card.

2. Flip the SD-card with firmware to the side of printer all the way.



※ Insert the SD-card into the receiver as indicated by the arrow. Fix the power code to the printer's main body, and turn off the power.

3. Pushing three buttons of "TABLE ↑" + "TABLE ↓" + "TEST" together on the panel at the front side bottom of the printer main body, turn on the printer power switch keeping to push three buttons.

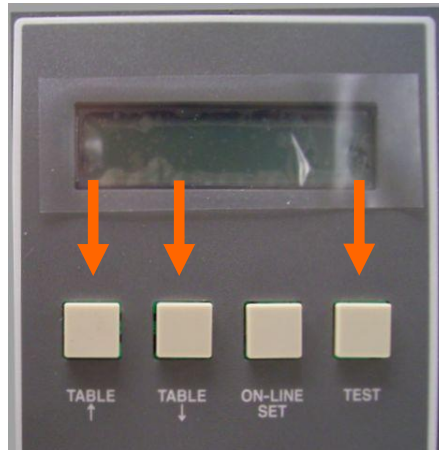

4. After that appears "System Boot" on the display, please be sure to confirm the "LENGTH" counter value is going up. Then you can release your fingers from the buttons.



5. At last it shows "UPDATE SUCCESS". Please find out if the firmware is updated. If not, try it again.



Please send any questions or requests you may have to the dealership or following address.

575 Prospect St., #211
Lakewood, New Jersey 08701-5073
Tel: 732.367.3100



fax: 732.367.7031
e-mail: sales@dalemark.com
website: www.dalemark.com

